

DUCATI

750 SS

900 SS

DESMO

instructions for use
and maintenance

MOTORCYCLES

DUCATI

750 - 900

Super Sport DESMO

SPECIFICATIONS - USE - MAINTENANCE

Every Motorcycle receives one copy of the present booklet.

GUARANTEE CARD

Every **DUCATI MOTORCYCLE** is supplied with a « Guarantee Card ».

Guarantee will not be recognized for motorcycles used for racing or for any events.

The contents of this booklet are not binding and though the main specifications of the motorcycle described and illustrated in this booklet remain unchanged, the DUCATI MECCANICA S.p.A. will be free to introduce modifications of some details, or of some accessories, if these modifications will be judged necessary or if they can improve the motorcycle, or finally for some technical-economical exigencies, but without being obliged to bring this booklet up-to-date.

Dear Sir,

We are very glad to welcome you among our clients, and feel sure that you will not fail to appreciate the magnificent performances of the DUCATI Motorcycles.

The magnificent performances and reliability of our machines reflect the experience gained throughout many years of successful racing both on track and road.

In order to obtain the fine service that the Ducati machine is capable of giving, it is essential that the instructions contained in this book be religiously adhered to.

If these instructions are followed closely, particularly during the running-in period of the machine, then you will be assured of many years trouble-free enjoyable riding.

We thank you and congratulate you on your wise choice of such a fine machine with unequalled performances.

DUCATI MECCANICA S.p.A.



MOTOCICLO DUCATI 750/SS
(mod. 1975)



MOTOCICLO DUCATI 900/SS
(mod. 1975)

A FOREWORD

The main goal of the present instruction booklet is to enable the owner of a DUCATI Motorcycle to use his vehicle in the best possible way.

The following notices are therefore only simple recommendations, suggestions, advices, and terms of reference, sufficient to enable anyone, having no experience or ignoring any special technical knowledge, to use his vehicle and to maintain it for a long time in perfect working condition.

In this booklet you will find the specifications of the new models of the precious series of motorcycles produced by DUCATI.



DUCATI SERVICING GARAGES

It is advisable, when taking the machine to a garage for repairs, to be sure that the garage is a Ducati agent as the staff will have been specially trained and the garage will have been equipped with the necessary tools to carry out any repair required (see pictures at page 57 and following).

This way you will be sure that the possible replacement of groups or parts will be made with genuine Ducati spares, in order to avoid unforeseeable troubles and to ensure interchangeability, good operation, and long life.

ORDERS FOR SPARE PARTS

It is absolutely necessary that each order for spare parts clearly states the following data:

- 1) The catalogue code of the spare part obtained from the Spare Part Catalogue;
- 2) Serial number of the engine (when ordering spare parts of the engine);
- 3) Serial number of the frame (when ordering spare parts of the frame).

For the requests of spare parts under the warranty, the Dealer has to fill in the special application form (in 3 copies) and send it together with the defective parts to the Ducati Distributor, for technical examination and the eventual replacement free of charge.

IDENTIFICATION NUMBERS

Every DUCATI 750/SS and 900/SS can be identified by its frame and engine serial numbers.

For the frame, the number is printed on the L.H. rear engine holding plate; for the engine the number is printed on the crankcase.

For the countries where required, these identification numbers are stamped also on a special plate put on the motorcycle.



- 1 - Engine serial number
- 2 - Frame serial number

PRECAUTIONS

TO BE FOLLOWED DURING THE INITIAL RUNNING-IN PERIOD



Fig. 1

During the first 1500 Km. (930 Miles)

- Do not force the engine, keeping it for a long time at a high number of revolutions, especially while going uphill;

TO GET THE BEST ENGINE RUNNING-IN, IT IS ABSOLUTELY NECESSARY THAT THE REV. COUNTER NEVER EXCEED 6,000 R.P.M. (750/SS) and 5,500 R.P.M. (900/SS).

Moreover we suggest to:

- Keep the chain well lubricated and in the correct tension.
- Check if the wheel spokes are loose: if so, go to your local Servicing Garage who can adjust them to the correct tension.

At 500 Km. (310 Miles)

Many operations must be carried out (see « Maintenance » at pages 46-47).

At 1000 Km. (620 Miles)

- Replace the oil in the engine crankcase and the correspondent filter (see « Lubrication » pages 14-17).
- Many operations must be carried out (see « Maintenance » at pages 46-47).

From 1500 to 3000 Km. (930 Miles to 1860 Miles)

The owner can expect better performances from his machine but he must not exceed 7000 r.p.m. (750/SS) and 6500 r.p.m. (900/SS) for the first 3000 Km. (1860 Miles).

At 3000 Km. (1860 Miles) the engine can be considered as fully run-in.

The more strictly and accurately you follow the aforesaid recommendations, the longer the engine life and the less the need for overhauling and tune-up.

ENGINE MAIN SPECIFICATIONS



Fig. 2

ENGINE

- two cylinders, 4 strokes, « L » longitudinal-type of 90°- supported by a cradle formed frame;

SPECIFICATIONS	750 SS	900 SS
Bore	80 mm.	86 mm.
Stroke	74,4 mm.	74,4 mm.
Cylinder capacity	748 cc.	863,9 cc.
Compression ratio	9,65:1	9,5:1
Max. power r.p.m.	8.000	7.000
Engine max. r.p.m.	8.800	7.900

- combustion chamber with hemispherical ceiling.
- deeply finned cylinders in light alloy, with special cast iron liners inserted;
- lightweight connecting rods in special steel, with roller cage at the big end (crank pin) and little end bushed to take the gudgeon pin;
- pistons in light alloy, pressforged with « H » skirt and 3 piston rings, 1 of which is a slotted oil scraper;
- cylinder heads cast in light alloy and closely finned, with inserted valve seats;
- inlet and exhaust pipes carefully and finely polished.

AIR COOLING

The close finning of both cylinders and heads facilitates the natural loss of heat, by air.

TIMING

It is a DESMODROMIC S.O.H.C. system, timed by four rockers (2 inlet and 2 exhaust ones) and by an overhead camshaft with four lobes, identical for the two motor-cycles, as follows:

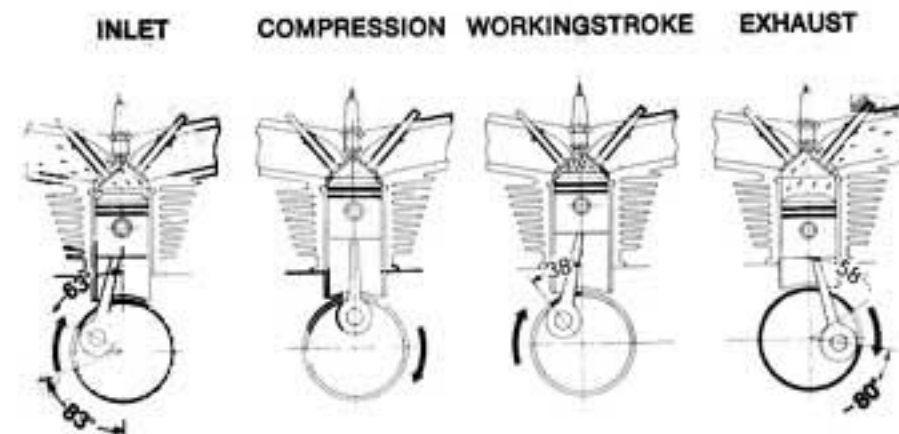

Fig. 3

The distribution data, with the control play of 0,2 mm. for inlet and exhaust between valve and rocker, are as follows:

Valve	Opening $\pm 5^\circ$	Closing $\pm 5^\circ$
Inlet	63° before TDC	83° after BDC
Exhaust	80° before BDC	58° after TDC

Timing adjustment

The timing gears are controlled by the driving shaft by means of three cylindrical gears and four couples of bevel gears, which drive the two heads.



Fig. 4

All these gears must be carefully timed, in compliance with the reference marks engraved on the toothed periphery.

The engine is timed when the above mentioned marks are disposed as indicated by the arrows in the illustration (see Fig. 4).

IMPORTANT! For valve tapped adjustment and concerned working plays see « Maintenance » at page 48.

PETROL FEED 750/SS AND 900/SS

The petrol feed of the engine is by gravity, by means of 2 Dellorto carburetors, PHM 40.

Carburetor	Atomizer	Diffuser	Idling jet	Main jet	Pin position
FRONT PHM 40D	265 AB	40	60	152	K4 2nd notch
REAR PHM 40S	265 AB	40	60	152	K4 2nd notch

The fibreglass tank has a capacity of 20 litres (Imp. gal. = 4,4; U.S. gal. = 5,28) with two 3-position cocks: closed, open, reserve. The reserve is about 2,5 litres (Imp. gal. = 0,55; U.S. gal. = 0,66).

As Optional we have available a metal tank with a capacity of 18 lts.

IMPORTANT! For the « Idling » adjustment, see paragraph « Maintenance » at pages 49-50.

LUBRICATION (see Fig. 7)

— Engine

The engine is pressure lubricated, by means of a gear pump driven by the shaft; this pump takes the oil through a first filter, from the lowest point of the crankcase which acts as an oil sump, and forces it through proper oil-ways, to all parts of the engine which have to be lubricated. The oil returns by gravity.

The sump capacity is of about 4,5 Kg. (10 lbs.) = lt. 5 (1.10 Imp. gal. = 1,32 U.S. gal.) Use AGIP Racing S-SAE 50 oil or equivalent.

The filler plug stick is marked by two notches in the spots where the oil level is respectively at its lowest and at its highest point.

Oil level measurement

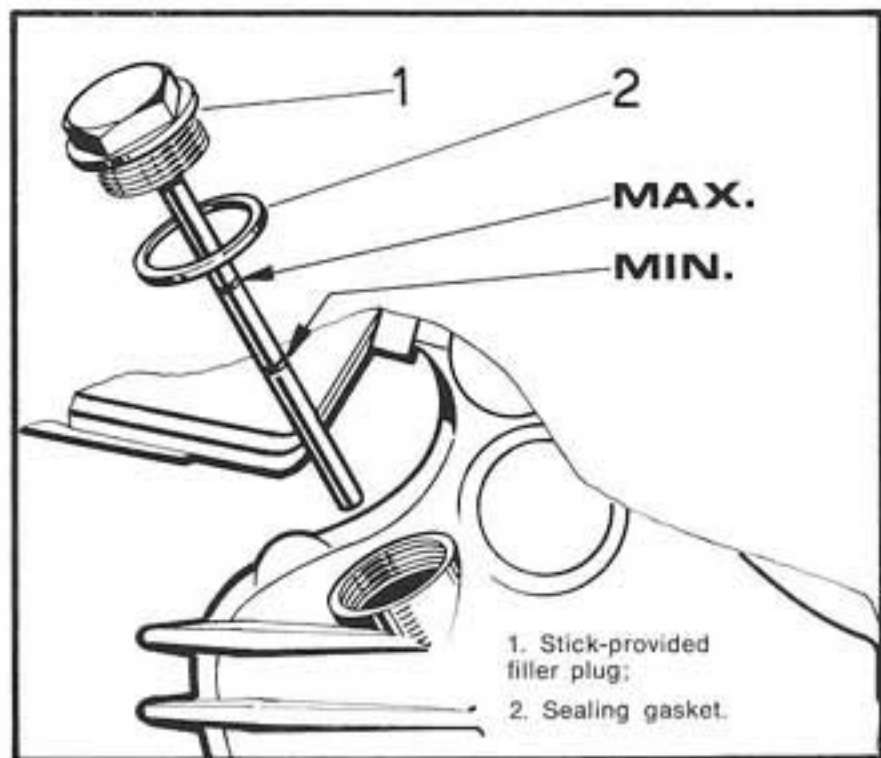

Fig. 5

The lubricating system of the DUCATI 750/S.S. and 900/S.S. motorcycles is very simple and requires no special maintenance except the renewal and eventual filling of the oil level every 1000 Km. (about 620 miles) and the total change of the oil, every 3000 Km. (about 1860 miles). Oil level is measured as follows:

- 1) Unscrew the filler plug and clean the stick.
- 2) Place the stick inside the filler until the plug rests on the edge.
- 3) Extract the stick and verify the oil level which must be within the « Min. » and « Max. » notches (see Fig. 5).

FILTER CARTRIDGE (see Fig. 6)

The oil filter is placed in the center of the engine between the twin cylinders and it is necessary to replace it with the first oil replacement at 1000 Kms. (620 Miles) and at 3000 Kms. (1860 Miles); after that mileage it is sufficient to replace it only every two oil changes.

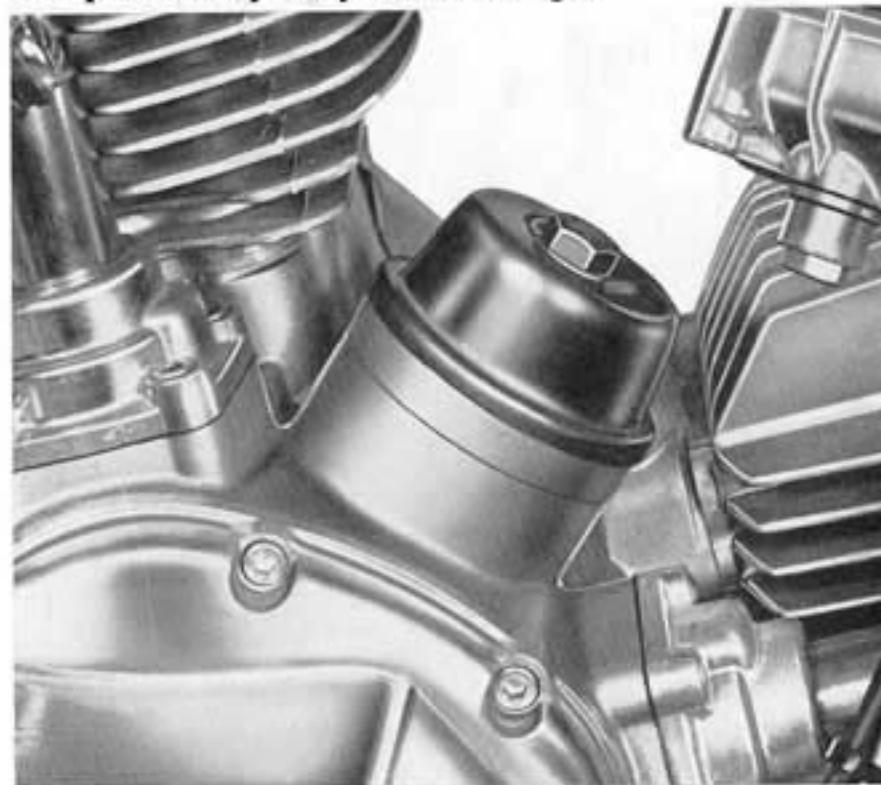

Fig. 6

LUBRICATION SYSTEM

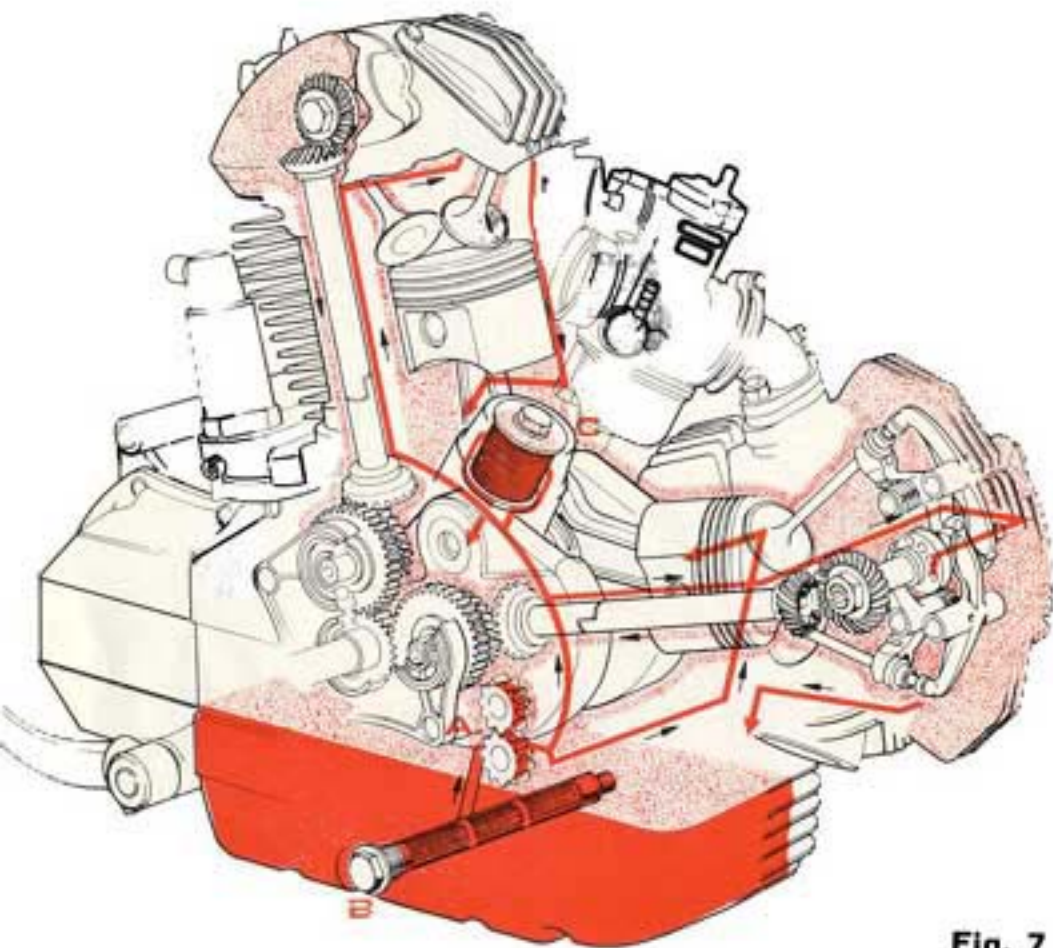

Fig. 7

- A) Oil pump.
- B) Filter cap.
- C) Filter cartridge

To drain the oil from the engine crankcase, remove the filter cap « B » (see Fig. 7).

SUGGESTED LUBRICANTS

Position	Lubricants or equivalents	Quantity
Engine	AGIP Racing S SAE 50.	4,5 Kgs.
Front fork	AGIP F1 ATF Dexron	280 cc.
Disc brakes	AGIP F1 Brake fluid Super HD	—
Chain	AGIP-Rocol Chain Lube Spray	—
Rear fork	AGIP F1 Grease 30	—
Speedo and Rev. counter	AGIP F1 Grease 30.	—

CENTRIFUGAL OIL FILTER (inserted in the main shaft)

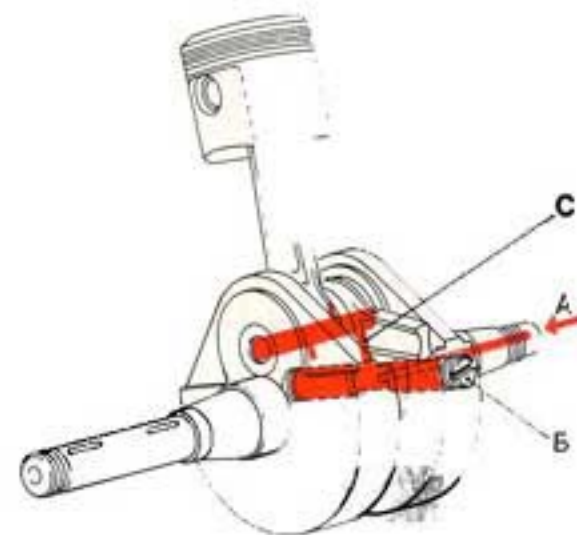

Fig. 8

How it works

The oil which is to be filtered, is brought to the filter through the pipe A; from here, the centrifugal force eliminates all the impurities (heavier than the oil), which accumulate all around the threaded plug B of the main shaft.

The filtered oil goes through the tube C to lubricate the con.rod big end (see Fig. 8).

ELECTRONIC IGNITION SYSTEM

This works by capacitor discharge. The capacitor is charged by the generator and discharged through the high-tension coil transducer when triggered by the magnetic pick-up.

The system consists of the following parts:

a) Ignition generator (Fig. 11)

This can be reached by removing the clutch cover on the L.H. side of the engine. This incorporates the electronic ignition coils and also the magnetic pick-up coils.

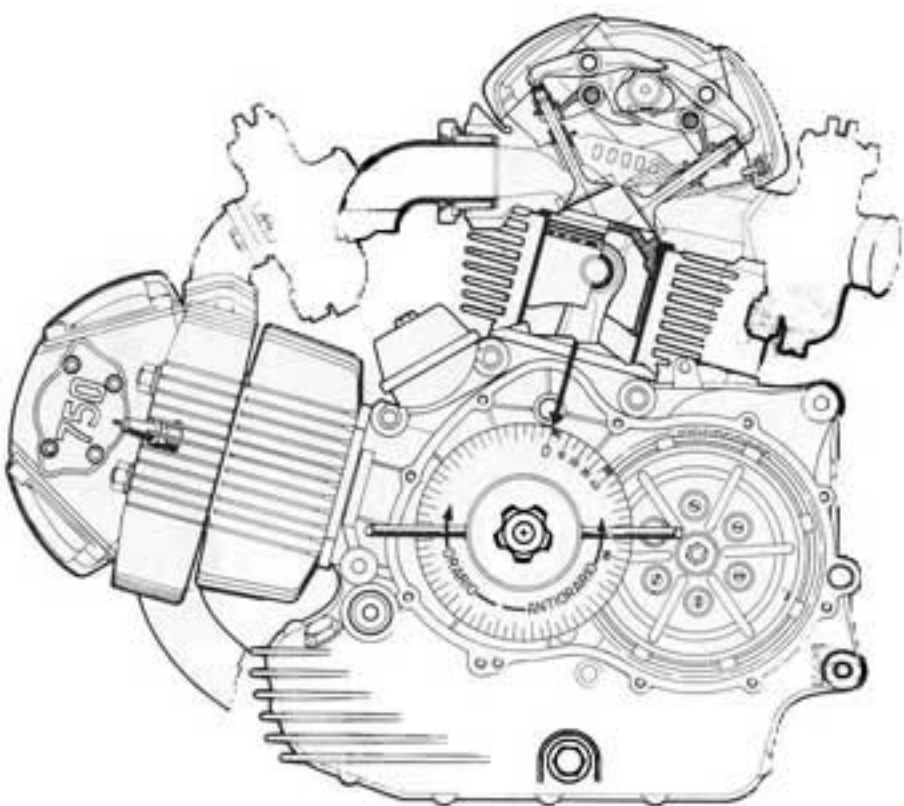

Fig. 9

orario = clockwise
antiorario = anticlockwise

- 1 - By means of a screwdriver, loosen the three screws that secure the plate.
- 2 - Fit the protractor wheel on the engine axis (see Fig. 9).
- 3 - Bring the piston of the vertical cylinder to TDC of compression stroke and set the indicator at « 0 » of the timing wheel.
- 4 - Rotate the driving shaft in the opposite direction of movement for about a quarter of a turn.
- 5 - Rotate the engine slowly in the direction of its movement stopping it at $35^{\circ} \div 38^{\circ}$ of advance (reading it on the wheel), (see Fig. 10).
- 6 - Insert a pin in the small hole on the flywheel magnet of the electronic generator and displace the plate till the pin enters in the corresponding back-plate hole (see Fig. 11).
- 7 - By means of the screwdriver fasten the three screws that secure the stator plate to the engine crankcase.

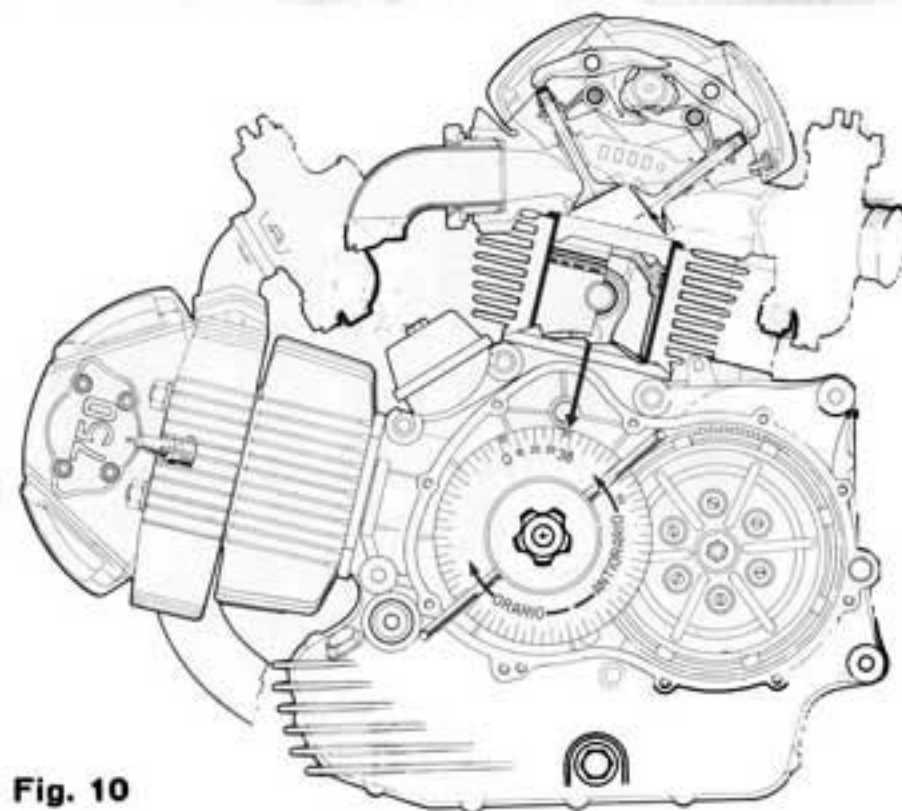

Fig. 10

Note: The spark advance at about 2000 rpm is automatically released with an amplitude of about 28° in a single stage.

ATTENTION! To remove the rotor from the generator, use the appropriate puller (see pages 60 and 61, item 11); never and for no reason tap on the rotor with a hammer.

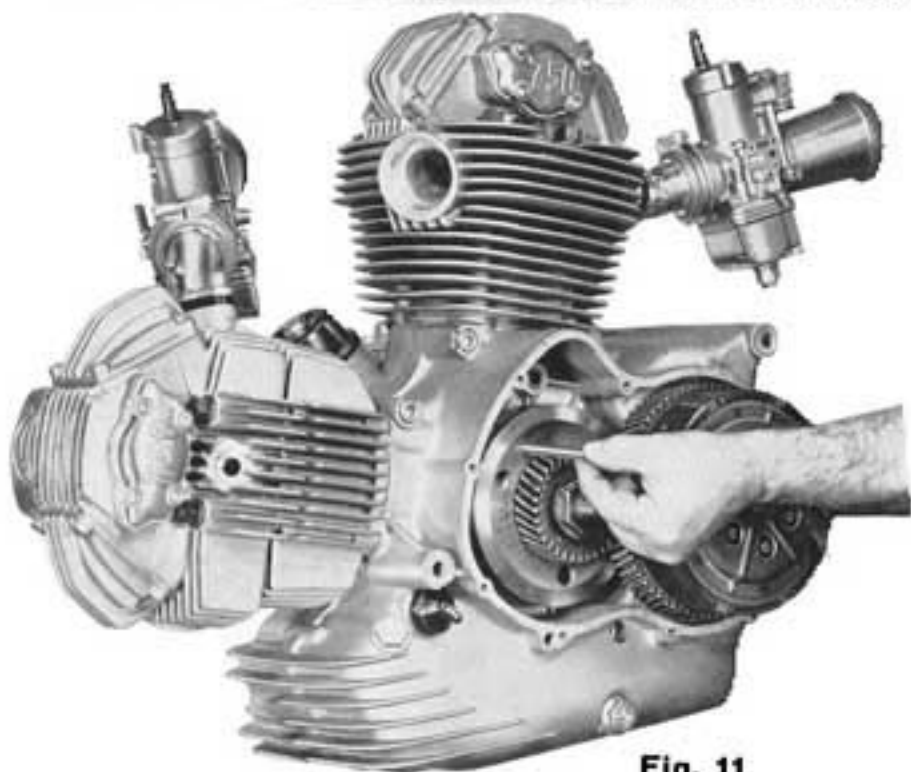

Fig. 11

b) Transducers

These are special coils working electronically, placed under the fuel tank and sheltered by special rubber caps for the electrical contacts.

c) Relay to stop the engine

It is placed under the tank and with key in « OFF » position, it grounds the two green wires of transducers. Of course, with key in « ON » position, the two wires are insulated.

On the 1976 motorcycles, this relay is placed inside the headlamp.

d) Spark plugs

The spark plugs are CHAMPION L 81 of the normal type or a similar model, and are located on the left side of the top of the cylinder heads.

The clearance between the electrodes must be 0.8 mm. (0.0315").

When refitting the spark plug make sure to fit it with the same angle of the head base; screw the plug lightly at first, then tighten it. This will avoid eventual risks of stripping the thread in the cylinder head (see Fig. 12).



Fig. 12

Advance checking through stroboscopic light

Carry out the following operations:

- 1) Mount the advance checking indicator 88713.0116 on the driving shaft center line, clutch side, after removing the plug.
- 2) Insert the stroboscopic light cable into the spark plug of the cylinder under check.

- 3) Start the engine until attaining about 3,000 rpm. and direct the stroboscopic light on the reference mark (I) of the cylinder in question, placed on the cover, clutch side.
- 4) The stroboscopic light must light up the phasing indicator perfectly aligned with the reference mark (I). If this is not, adjust it by rotating the stator base of the ignition generator: to advance rotate anticlockwise; to retard rotate clockwise (see Fig. 13).

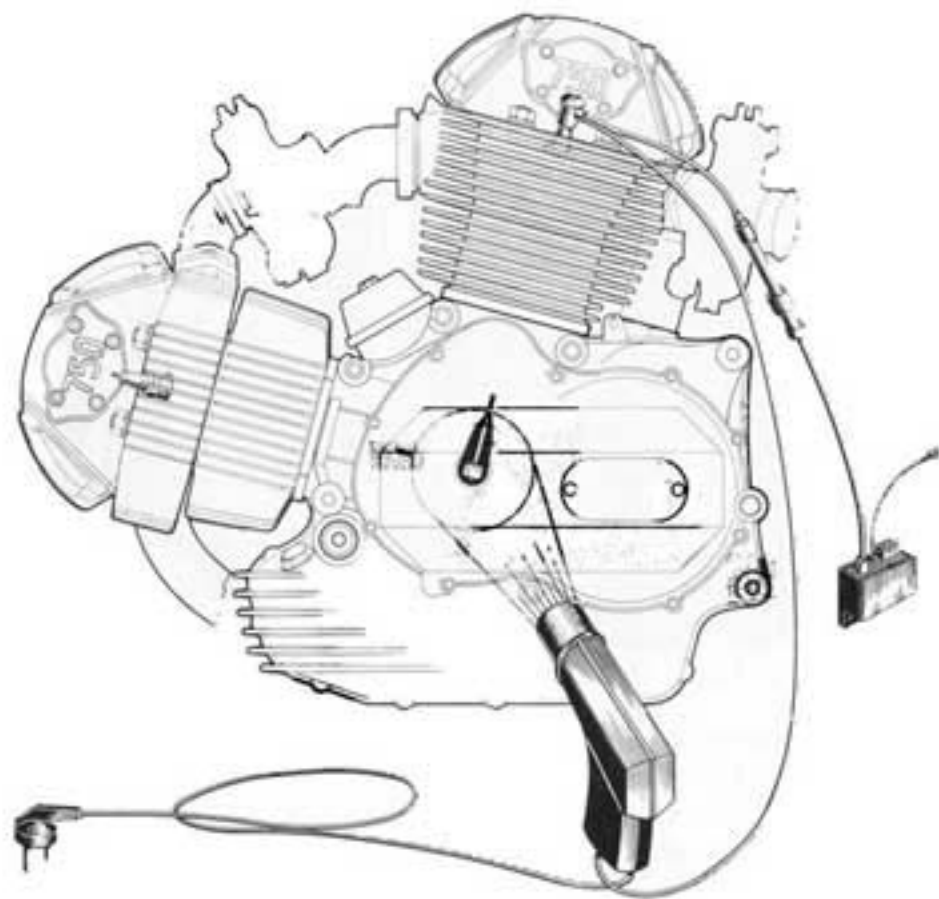

Fig. 13

TRANSMISSION

The transmission consists of the primary transmission, the clutch, gearbox and secondary transmission. The clutch is of the multiple plate type with steel discs and friction material. It turns in an oil bath and is mounted on the primary shaft of the gear box.

The clutch housing, made of special wear resisting steel, rotates on two inner bearings which are set at an adequate distance.

It is conveniently lubricated together with the engine gear.

The clutch is operated by a handlever placed on the left side of the handlebar.

The transmission between engine and primary shaft of the gearbox, is obtained by means of helical gears and the reduction ratio is $32/70 = 1/2,187$.

The gearbox is in the crankcase; the gears for the 5 speeds are constantly meshed and operated by a foot pedal.

The transmission ratios of the gears are the following:

- bottom gear $19/34 \times 24/30 = 1/2,237$
- second gear $24/30 \times 24/30 = 1/1,562$
- third gear $27/26 \times 24/30 = 1/1,204$
- fourth gear direct drive = 1/1
- top gear $31/22 \times 24/30 = 1/0,887$

The transmission between the gearbox and the rear wheel is obtained by a chain Reinold BS — 5/8 x 3/8 and its speed ratio is for both motorcycles (750 and 900 SS):

$$\begin{array}{l} 16/40 = 1/2,500 \quad 750/SS \\ 16/37 = 1/2,312 \quad \} \\ 16/36 = 1/2,250 \quad \} 900/SS \end{array}$$

N.B. - In the 900 SS motorcycle we advise to fit, specially for highway use, a smaller sprocket ($Z = 36 \div 37$) allowing the same speed at lower r.p.m.

EXAMPLE: HOW TO CALCULATE THE MOTORCYCLE THEORETIC SPEED

The theoretical calculation of the motorcycle speed is made as follows:

$$V = \frac{N \times 60 \times C}{1,000 \times R} \text{ of which:}$$

V = speed in Kms. per hour.

N = Engine max. r.p.m.

C = Rear tire rolling circumference in metres.

R = Engine/rear wheel total ratio.

To obtain the speed attainable with the motorcycle you have first to calculate the « R » value of the different gears:

$$\text{1st gear} \quad R = \frac{70}{32} \times \frac{34}{19} \times \frac{30}{24} \times \frac{40}{16} = 12,234$$

$$\text{2nd gear} \quad R = \frac{70}{32} \times \frac{30}{24} \times \frac{30}{24} \times \frac{40}{16} = 8,545$$

$$\text{3rd gear} \quad R = \frac{70}{32} \times \frac{26}{27} \times \frac{30}{24} \times \frac{40}{16} = 6,583$$

$$\text{4th gear} \quad R = \frac{70}{32} \times \frac{1}{1} \times \frac{40}{16} = 5,469$$

$$\text{5th gear} \quad R = \frac{70}{32} \times \frac{22}{31} \times \frac{30}{24} \times \frac{40}{16} = 4,851$$

Considering the « rolling circumference » of the rear tire C = 2,020 metres, the speeds referred to 1,000 r.p.m. are as follows:

$$\text{1st speed} \quad V = \frac{1,000 \times 60 \times C}{1,000 \times R} = \frac{60 \times 2,02}{12,234} = 9,907 \text{ Km/h}$$

$$\text{2nd speed} \quad V = \frac{1,000 \times 60 \times C}{1,000 \times R} = \frac{60 \times 2,02}{8,545} = 14,184 \text{ Km/h}$$

$$\text{3rd speed} \quad V = \frac{1,000 \times 60 \times C}{1,000 \times R} = \frac{60 \times 2,02}{6,583} = 18,411 \text{ Km/h}$$

$$\text{4th speed} \quad V = \frac{1,000 \times 60 \times C}{1,000 \times R} = \frac{60 \times 2,02}{5,469} = 22,161 \text{ Km/h}$$

$$\text{5th speed} \quad V = \frac{1,000 \times 60 \times C}{1,000 \times R} = \frac{60 \times 2,02}{4,851} = 24,985 \text{ Km/h}$$

To calculate the motorcycle speed it is necessary to multiply the above values by the engine max. r.p.m.

VEHICLE MAIN SPECIFICATIONS

FRAME

The frame is of the open double cradle type, made of high tensile steel and very sturdy structure designed on the basis of our long experience acquired in the competitions for motorcycles of this category.

FRONT SUSPENSION

The front suspension consists of a telescopic-hydraulic long-stroke, double action fork, with steering stop. Each fork leg contains 280 cc. (17 cu.in.) of oil AGIP F1-ATF-DEXRON or equivalent.

WHEELS

The wheels are of the spoke type with light alloy rims as follows:

Material	Profile	Wheel rim size	
		Front	Rear
Light alloy	Normal	18" x 3"	18" x 3"

The wheels are with detachable spindle. The rear wheel has a special cushion drive and can be dismantled without removing the chain.

Tyres and pressures are as follows:

Model	Type	Front wheel		Rear wheel	
		Tyre size	Pressure Kg/cm ² (lb/sq.in.)	Tyre size	Pressure Kg/cm ² (lb/sq.in.)
1975	Metzeler	3,50 V 18 Block C7 - Racing	2,4 ÷ 2,5 (34,85)	3,50 V 18 Block C7 - Racing	2,6 ÷ 2,7 (37,69)
1976	Pirelli	3,50 V 18-SS - MT 18	2,2 ÷ 2,3 (32)	120/90 V 18 SS - MT 18	2,3 ÷ 2,4 (33,43)

REAR SUSPENSION

The rear suspension consists of a swinging fork with double action, hydraulic adjustable load dampers (shock-absorbers) which can be adjusted for five different loads (see Fig. 14).



Fig. 14

FORK FULCRUM-SPINDLE

In this motorcycle the fork fulcrum-spindle is fixed to the frame, while the fork provided with bronze bushes rotates on it.

This system gives the machine greater sturdiness.

SYLENCER HOMOLOGATION

In the 750/SS frame, and precisely R.H. near the rear fork fulcrum, you will find a small plate with printed the European homologation numbers of sylencers: E3-9R 11872 (see Fig. 15).

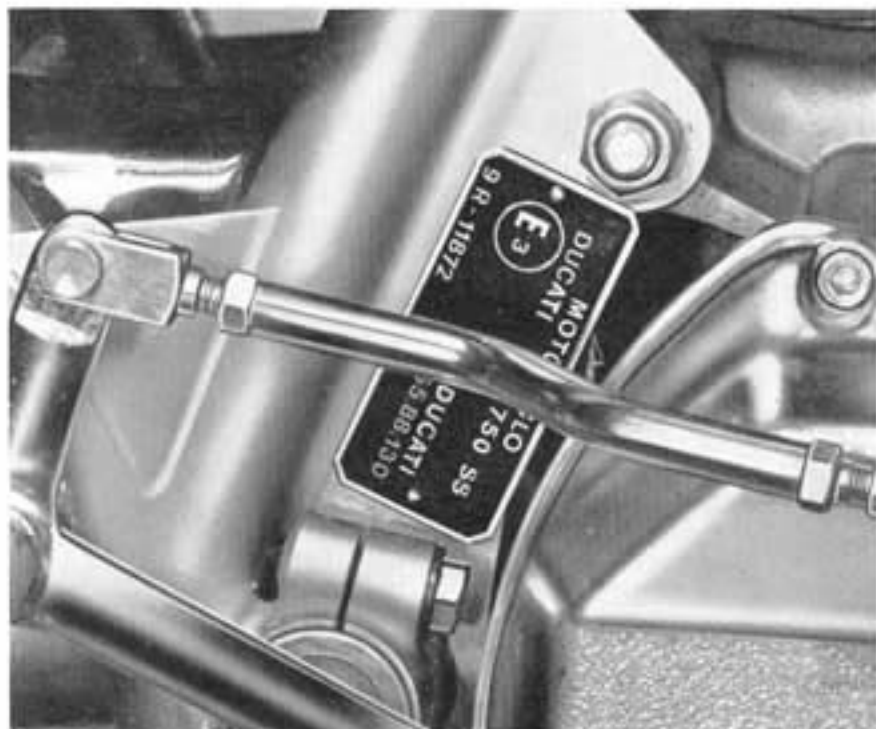

Fig. 15

BRAKES

The front brake is of the double disc type \varnothing 280 (11") with telehydraulic control by hand on the R.H. handlebar; the rear brake is of the disc type \varnothing 229 (9") with pedal control on the L.H. side (for 1975 model) or on the R.H. side (for 1976 model).

SADDLE

One-seat comfortable saddle, specially designed for racing purposes, it may be opened by means of a zip to enter the tool box (see fig. 16).

Here, in the 1976 model motorcycles you will find also an expansion chamber for the crankcase gases.



Fig. 16

To enter into the fuse box, it is necessary to remove the saddle from the motorcycle.

To remove it, unscrew the two chrome screws at bottom of tail-end, then slide the saddle towards the rear end of motorcycle.

ELECTRICAL EQUIPMENT - LIGHTS AND CONTROLS

(see wiring diagrams)

The electrical system consists of the following main parts:

- 1) Headlamp
- 2) Dashboard
- 3) Horn
- 4) Stop switches
- 5) Key switch
- 6) Fuse box
- 7) Battery
- 8) Regulator
- 9) Alternator
- 10) Plate holder
- 11) Controls
- 12) Direction indicators (trafficators)

1) Headlamp

The headlamp has a large diameter (\varnothing 170 mm. = 6.69") and supplies a powerful light beam by means of a twin-light, 12 Volt 55/60 W - H 4, iodine bulb. The headlamp is also provided with a 12 V - 3 Watt parking light.

Inside the headlamp there are: a relay for headlamp, a flasher unit for the direction indicators.

Lamps for direction indicators must be of 20 + 21 Watt at 12 Volt as max.

2) Dashboard (see Fig. 17 - 1975 Model)

Placed inside the half-fairing, it contains:

- Rev. counter and speedometer
- 1 GEN warn. light — white colour = Inserted key
- 1 BEAM warn. light — red colour = Main beam
- 1 LIGHT warn. light — green colour = Parking lights.
- 1 three-position switch (Lights — Off — Parking) in the 1975 motorcycles; a key-switch in the 1976 motorcycles.

3) Horn

The 12 Volt horn is placed under the fuel tank in an adequate position to have the highest efficiency.

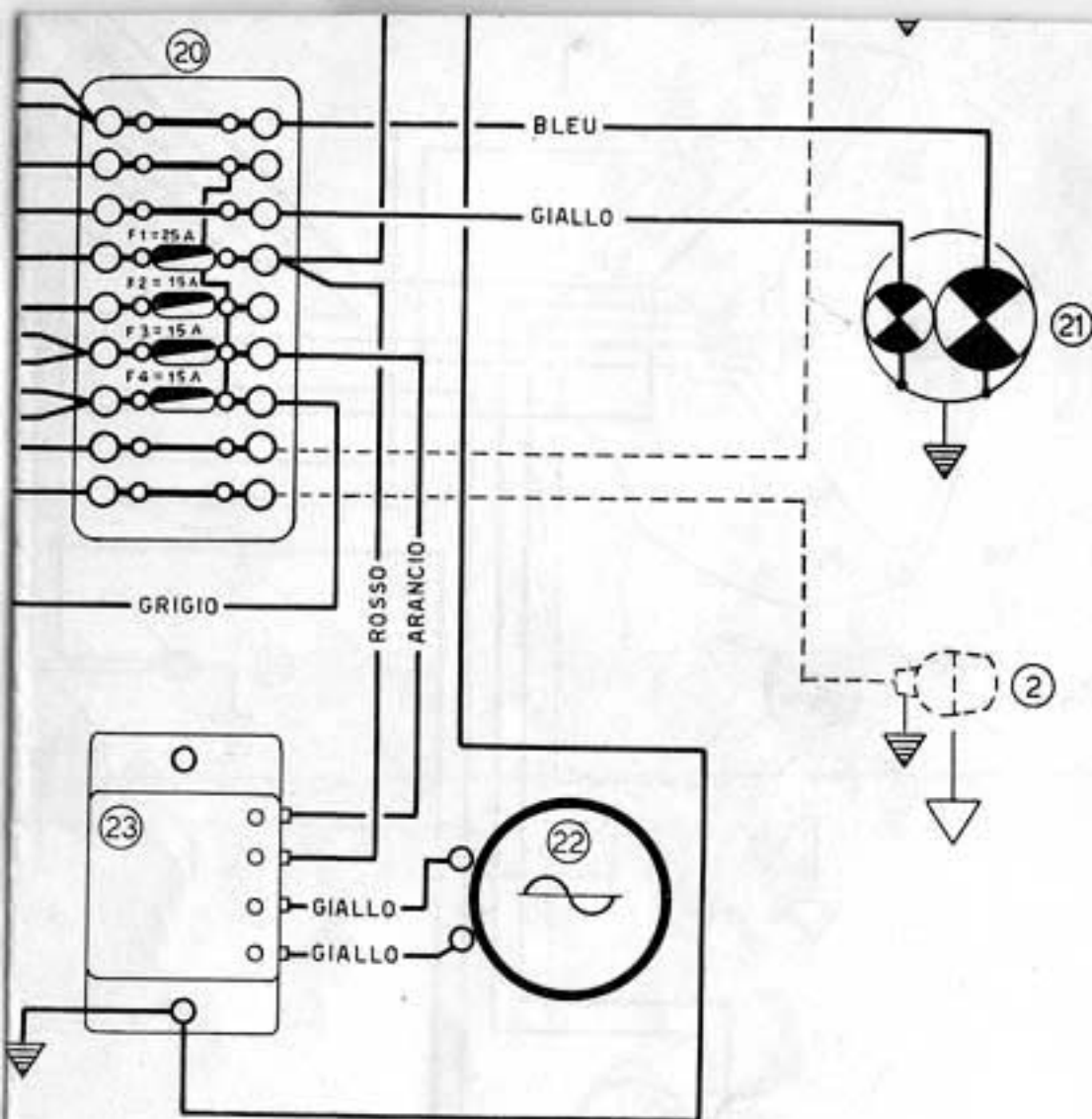

1976 ELECTRIC SYSTEM DIAGRAM

N BEAM WARN. LIGHT	19	BATTERIA 12 V - 12 Ah YUASA 12N-12A-4 A	BATTERY
KEY WARN. LIGHT	20	SCATOLA FUSIBILI	FUSE & TERMINAL BOX
ALL LIGHTS WARN.	21	LUCE POSIZ.-STOP-TARGA 12 V - 5/21W	TAIL LIGHT-STOP-PLATE
FETY LOCK SWITCH	22	ALTERNATORE 12V - 220 W	ALTERNATOR
SPARK PLUG NO. 1	23	REGOLATORE ELETTRONICO	ELECTRONIC REGULATOR
SPARK PLUG NO. 2	24	INTERRUTTORE STOP POSTER.	REAR STOP SWITCH
TRANSDUCER NO. 1	25	INTERRUTTORE STOP ANTER.	FRONT STOP SWITCH
TRANSDUCER NO. 2	26	AVVISATORE ACUSTICO 12 V	HORN
RONIC IGNITION GEN.	27	MASSA GENERALE	GENERAL EARTH

It is operated by means of the push button L.H. on the handlebar.

4) Stop lamp switches

Both of them are inserted in the hydraulic circuit: the front one is fitted on the central union of the two pipes going to the calipers; the rear one is fitted directly to the brake pump under the L.H. side cover. Both switches control the same device as they switch on the stop red light when braking.



Fig. 17

A = Light
O = Off
B = Parking

5) Key switch

In the 1975 motorcycles it is placed on the rear side of the fuel tank and works in two positions: Stop, Running.

In the 1976 motorcycles — on the contrary — it is placed in the center of the dashboard and works on three positions: Parking, Stop, Running.

6) Fuse box

It is placed under the saddle and contains 4 fuses: F1 of 15 Amp. protects the parking lights; F2 of 15 Amp. protects the headlamp lights;

F3 of 15 Amp. protects the horn and stop light;
F4 of 15 Amp. protects the direction signal lamps.

Attention! While replacing a fuse, load the contact springs to allow to fit the fuse well tight.

If a fuse blew out, check to find the cause of the blowout before replacing it, otherwise the fuse will continue to blow.

7) Battery

The battery is a YUASA 12N - 12A - 4A, of 12 Volts - 12 Ah. It is provided with a transparent case allowing to check the level of the electrolyte, and is placed under the R.H. side cover, in a special rubber box; it is elastically fixed.

Attention: The motorcycle, for racing or emergency purposes, can run also without battery, however it is necessary to disconnect the two green wires going from the transducers to the « engine stop » relay under the petrol tank. Under these conditions the lights and all the other devices as horn etc. must not be utilized.

To check the recharge current, always insert the ammeter with still engine.

8) Regulator

The regulator consists of a light alloy box placed under the L.H. side cover, containing the diodes to rectify the alternator current converting it into direct current for the recharge of the battery. Moreover it contains a special electronic set working in connection with the battery tension: if the battery is down (low tension) the recharge current will be high; if the battery is charged (normal tension 12 to 14 Volt), the current will be 2 to 4 Amp.

During the long runs on highways, especially with switched out headlamp, the battery tension could

reach 14 Volts; in this case the regulator will stop the recharge current.

It is very important that the regulator be clamped on the frame in order to dissipate the heat produced by the diodes.

9) Alternator

Its power is of about 200 Watts. It is placed within the engine, distribution side. Two yellow wires come out from it, and have to be directly connected to the regulator according to their colour.

Important! When removing the distribution side cover, take care not to damage the alternator windings.

10) Plate-holder

It is placed together with the tail light, on the rear mudguard and contains a 12 Volt — 5/21 Watt twin-light bulb.

1 Controls on the handlebar

Placed L.H. on the handlebar, contain:

in the 1975 motorcycles:
— main beam and low beam switch;
— horn press button.

In the 1976 motorcycles:

— a three position light switch: « Off » - « Parking lights » - « Lights »;
— main beam and low beam switch;
— horn press button;
— headlamp flash button;
— R.H. and L.H. flasher switch.

12) Direction flashers

Not fitted. However in the circuit you will find the wiring and inside the headlight there is its flash unit. In the 1976 motorcycles you will find also a switch inside the control placed L.H. on the handlebar.

SOME ADVANTAGES OF THE ELECTRIC EQUIPMENT WITH ELECTRONIC REGULATOR

The electrical system with electronic regulation of current offers real advantages in comparison with the re-charge installation adopted on the other motorcycles.

The advantages can be summarized as follows:

- 1) Adjustment of the automatic charge.
- 2) No electrical contacts in the regulator and consequently there is a greater safety in the working.

Anyway great care should be taken not to disconnect the battery cables when the engine is running, because the regulator would surely remain damaged.

WIRING SYSTEM OPERATION (see Fig. 18)

1) Key inserted in « Parking » position (1976 model only)

- The LIGHT warn. light is lit together with the parking lights. The key can be removed, if so desired.
- The engine cannot be started.

2) Key in « Stop » position.

- The GEN warning light is switched out.
 - It is impossible to let the engine start because the two transducers are earthed; moreover the entire equipment is totally insulated and the main lights cannot be switched on, as well as the other electric parts.
- The key can be removed, if so desired.

3) Key inserted in « On » position.

- The warning light GEN is lit.
- It is possible to start the engine and the battery is conveniently recharged.
- It is possible to switch on the headlight, the parking lights, the horn, etc.

During the working of all these electrical parts the battery is recharged all the same and the number of rev. for a balanced charge-rate will of course, rise:

Revs. for balanced charge-rate with switched out headlights = 1,000 r.p.m.

Revs. for balanced charge-rate with switched on headlights = 2,200 r.p.m.

By revs. for balanced charge-rate, we mean the engine revs. at which the battery begins to be recharged. Of course, if we fit on the motorcycle additional lights and horns the number of revs. for a balanced charge-rate will overload the alternator windings too.

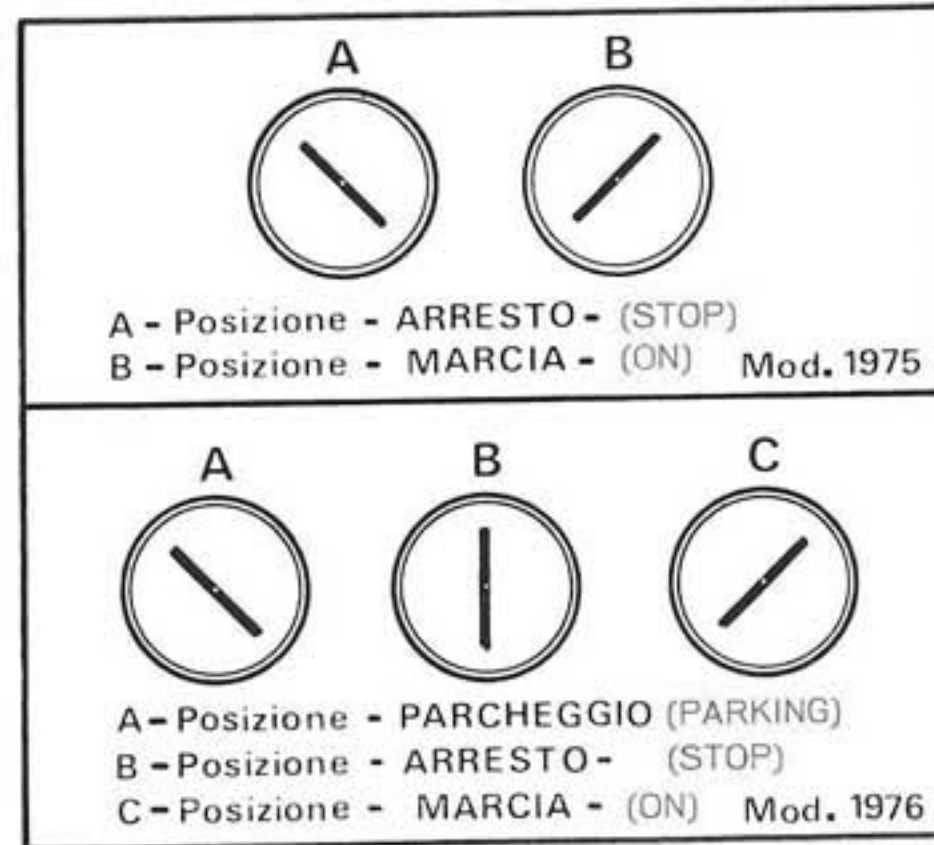

Fig. 18

The alternator can, of course, stand a certain additional load at condition however it will not exceed 35 to 40 Watts of absorption. Under these conditions however, there is

the risk to be compelled to sometimes recharge the battery, unless the engine revs. have been kept beyond 3,000 ÷ 3,500 r.p.m.

The recharge current intensity is rectified (according to the battery condition) by the electronic rectifier, which automatically stops the recharge when the tension exceeds 13,8 to 14 Volts (see « Regulator » at page 32).

Note! The GEN warning light remains lit also when the motorcycle is running.

CONTROLS

750/SS and 900/SS motorcycles 1975 model (see Fig. 19)

As it has been seen in the previous paragraph, on the Left side of the handlebar, is placed near the fixed handgrip, the electrical control: main beam, low beam, horn button. In front of the handgrip there is the clutch lever. On the Right Side, there is the throttle handgrip and in front of it, the front brake lever.

At the Right Hand of the motorcycle, near the footrest, there is the 5 speed gear lever and the kickstart pedal. At the Left Hand there is the foot brake lever.

750/SS and 900/SS motorcycles 1976 model (see Fig. 20).

These motorcycles have the controls so modified:

- electrical control L.H. on the annular type handlebar including: the headlamp switch; main and low beam switch; horn press button; headlamp flash button and double switch for side flashers;
- rear brake lever R.H. on the motorcycle;
- gearcharge lever L.H. on the motorcycle.

Note: on the two models the Stop light, as already said, is controlled by both brakes, by means of two separate switches connected with their corresponding control levers.

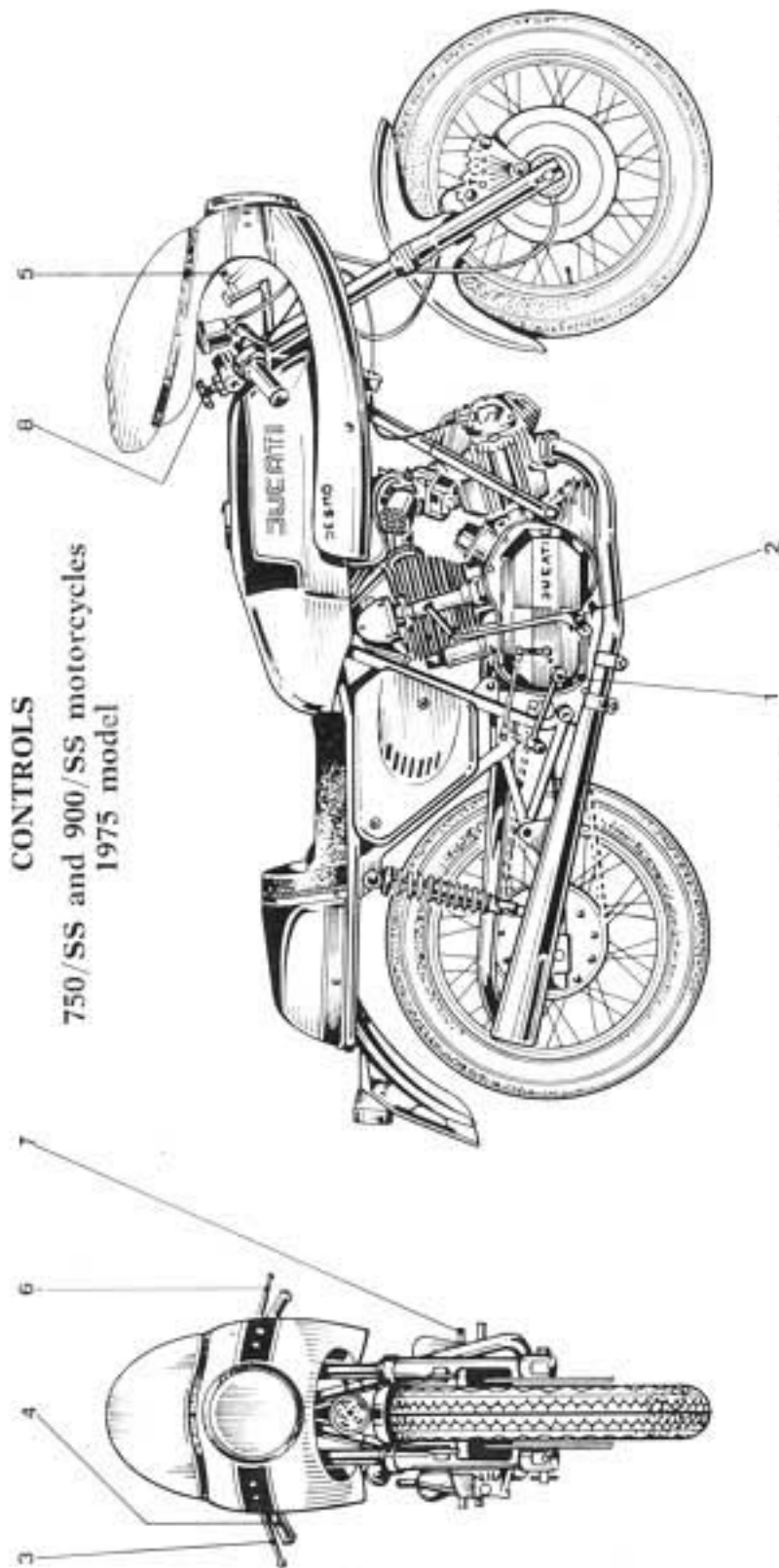
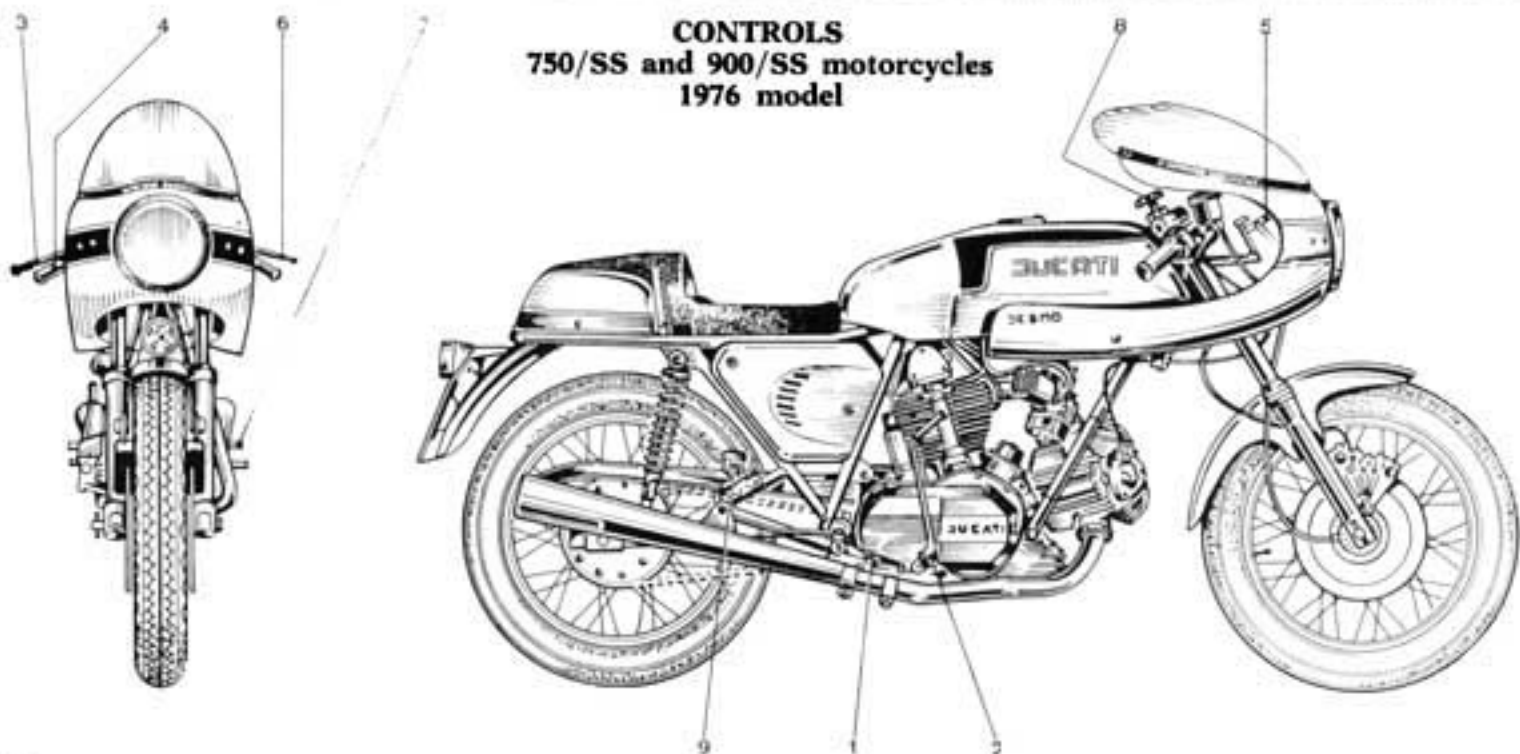

Fig. 19

LEGEND

- | | |
|--------------------------------|------------------------------|
| 1 - Change gear lever | 5 - Dashboard |
| 2 - Starting articulated lever | 6 - Clutch lever |
| 3 - Front brake control lever | 7 - Rear brake lever |
| 4 - Accelerator hand grip | 8 - Steering damper handgrip |

CONTROLS
750/SS and 900/SS motorcycles
1976 model



LEGEND

- | | |
|--------------------------------|------------------------------|
| 1 - Rear brake lever | 5 - Dashboard |
| 2 - Starting articulated lever | 6 - Clutch lever |
| 3 - Front brake control lever | 7 - Change gear lever |
| 4 - Accelerator hand grip | 8 - Steering damper handgrip |
| | 9 - Rear brake pump |

Fig. 20

38

OVERALL DIMENSIONS AND WEIGHTS

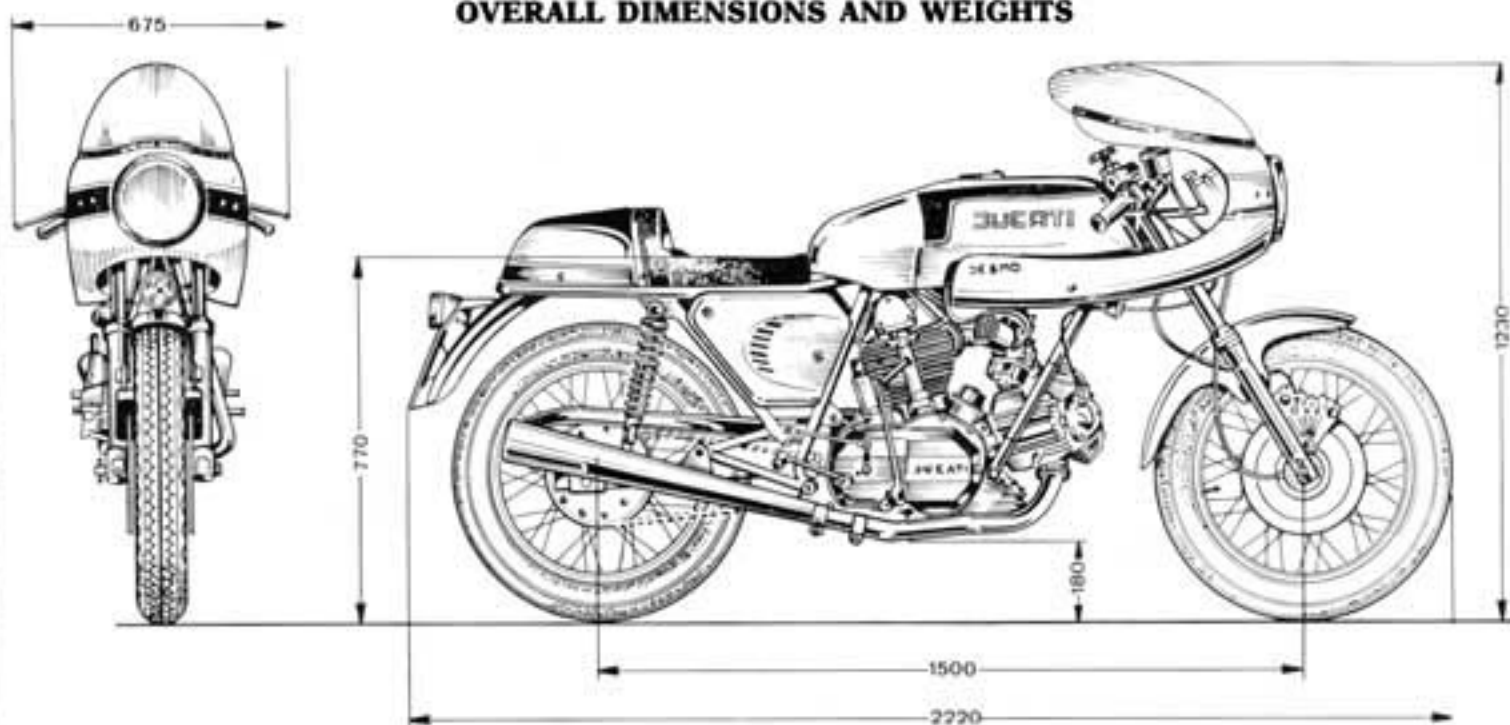

	900 SS	750 SS
- empty	Kgs.187 (412,8 lbs)	188 (415,0 lbs)
WEIGHTS: - empty (but with petrol and oil)	Kgs.205 (452,5 lbs)	206 (454,7 lbs)
- with pilot	Kgs.275 (607,0 lbs)	276 (609,3 lbs)

Fig. 21

39

TOOL-KIT

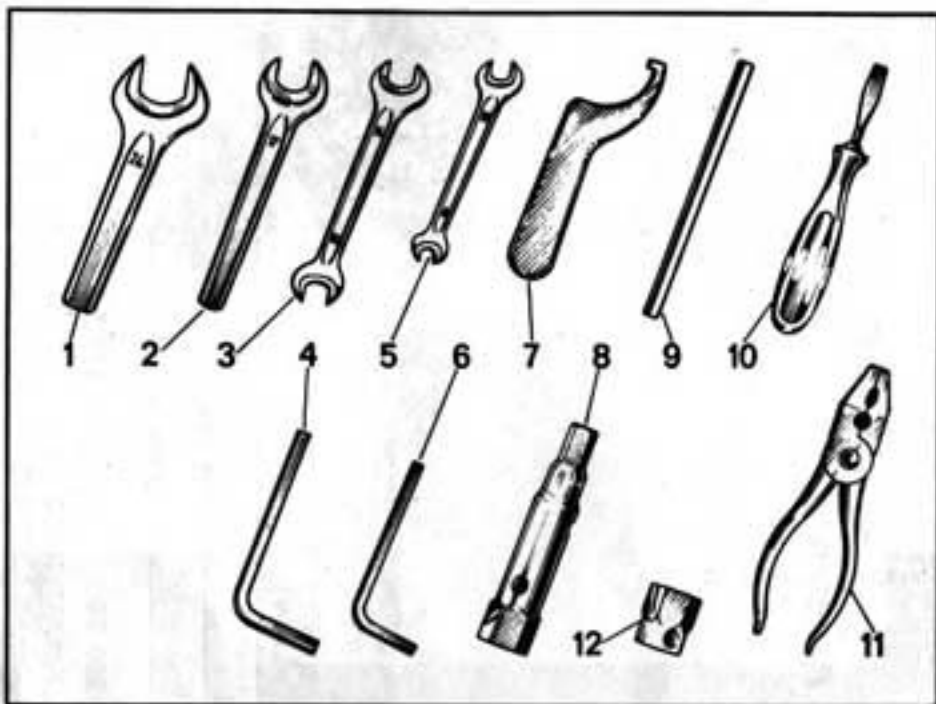

Fig. 22

TOOLBOX

A toolbox of ample capacity is placed in the rear part of the saddle and contains the spanners and tools needed for normal inspections or repairs that the rider himself can carry out (see Fig. 16).

- 1 - Normal spanner of 24 mm.
- 2 - Double spanner 17 mm.
- 3 - Double spanner 13-14 mm.
- 4 - Inner hexagon spanner 8 mm.

- 5 - Double spanner 8-10 mm.
- 6 - Inner hexagon spanner 6 mm.
- 7 - Spanner for shock-absorber adjustment
- 8 - Hexagon spanner for spark plugs and cover plug.
- 9 - Pin for box spanner
- 10 - Screwdriver
- 11 - Universal pliers
- 12 - Box spanner 21 mm. for oil plug.

PERFORMANCES

The max. speed can be obtained only by scrupulously following the running-in rules described at the pages 8 and 9, and periodically executing the maintenance operations listed at the pages 46-47.

Tank capacity: 20 lts (about) = Imp. Gall. 4,40 = U.S. Gall. 5,28

MODEL	Consumption (CUNA rules)	Fuel distance per tank	Max. speed	Max. r.p.m.
750 SS	18 Km/lt. 50,84 M/imp. Gal. 42,32 M/U.S. Gal	360 Km. 225 Miles	220 Km/h 137 M/h	8,800
900 SS	18 Km/lt. 45,2 M/imp. Gal. 37,6 M/U.S. Gal.	320 Km. 200 Miles	225 Km/h 140 M/h	7,900

Important

At any speed, do not exceed the max. r.p.m. of the engine, that is 8800/1, for 750 SS and 7900/1' for 900 SS.

Failure to comply with the above recommendations absolves the manufacturer from all liability as to possible troubles occurring in the engine.

HOW TO USE THE 750 SS and 900 SS

FILLING UP AND STARTING OF THE COLD ENGINE

Before starting the engine, make sure that in the tank there is sufficient fuel for the distance you wish to travel, that the fuel taps are open and that the engine lubricating oil is at the right level.

We advise to use AGIP SINT/2000 - SAE 10 W 50 or equivalent.

To start the engine, follow these instructions:

- 1) Place the motorcycle on the central stand.
- 2) Engage neutral gear.
- 3) Give the throttle handgrip two turns just to enrich the carburation.
- 4) Flood the two carburetors by means of the ticklers on the same carbs.
- 5) Insert the key in « On » position.
- 6) Firmly kick the starter pedal.

If the engine does not start, repeat this operation, varying at the same time more or less the opening of the throttle by means of the handlebar grip. **Once the engine is started, do not race immediately, especially when the engine is cold, but before accelerating the engine let the lubricating oil warm up to facilitate its circulation throughout the engine, so as to reach all moving parts.**

Note: do not continually rotate the twist-grip whilst kick-starting the engine, as this will operate the accelerator pumps and flood the carburetors.

RIDING AWAY AND RUNNING INSTRUCTIONS FOR THE 1975 MOTORCYCLES (see Fig. 23-24)

With the engine running, disengage the clutch and, using your toe (see Fig. 23), pull up the arm of the gear-change lever. When this lever is left to itself, it returns to the original position. With this move the bottom gear is now engaged. Now turn the throttle hand grip little by little and release gradually your hold on the

clutch lever; the motorcycle begins slowly to go under way. With the clutch lever completely released, let the motorcycle increase its speed. To pass now from bottom gear into second gear, turn back throttle hand grip fully and quickly; and after having disengaged the clutch press downwards the gearchange lever. Now turn forward the throttle hand grip again, releasing at the same time the clutch lever. Similar operations are carried out in order to change from second gear into third gear, from third gear into fourth gear and from the fourth to the top gear.

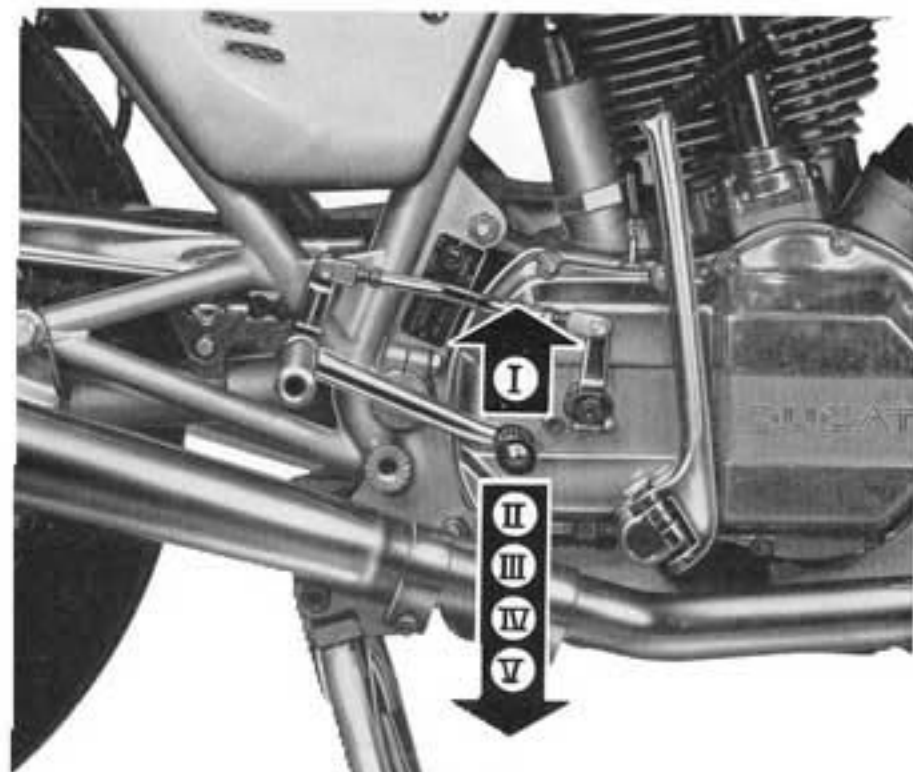

Fig. 23

To change down from a high gear to a lower one, operate as follows: close the throttle, pull the clutch lever, accelerate the engine momentarily, thus synchronizing the gears about to be engaged, engage the lower gear and then let go off the clutch lever.

A good motorcyclist will make use of the controls intelligently and at the right time. When riding uphill and the engine tends to slow down, change to a lower gear at once; do not « hang on » to a higher gear when the effort required from the engine advises to use a lower gear. When the engine turns at a low number of revolutions, do not accelerate low quickly: thus you avoid any over supply of fuel and too harsh drive to the transmission.

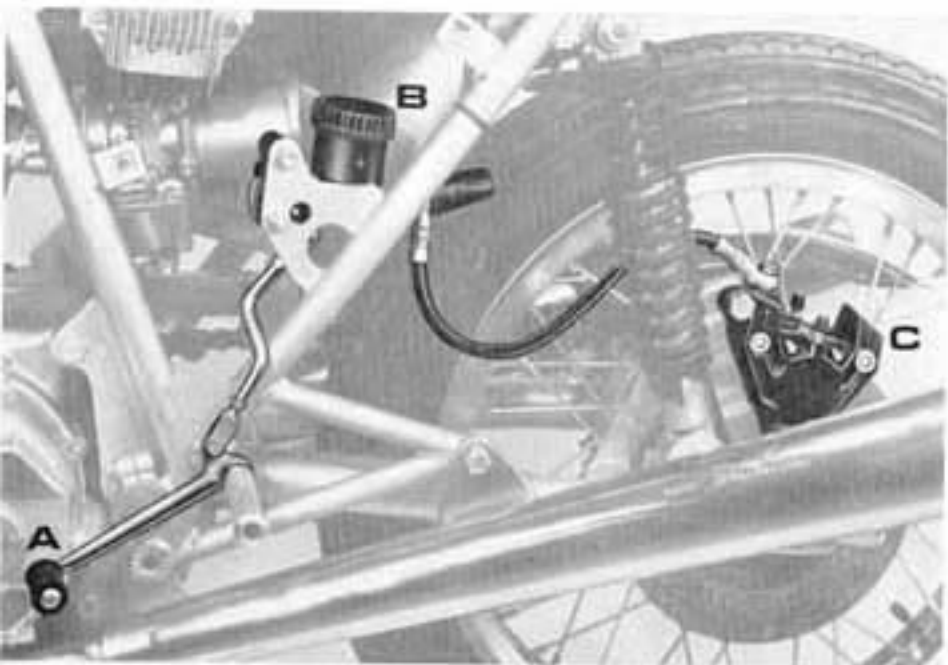

Fig 24

A - Foot-lever
B - Pump
C - Caliper

The clutch should not be held long disengaged with a gear engaged, because the clutch plates will become overheated, causing rapid wear by friction.

Except in case of emergency, never use the brakes brutally when you are already near behind the obstacle, but throttle down the engine in right time and then make use of the brakes.

N.B. - These instructions are applicable to the 750/SS and 900/SS motorcycles 1975 model; anyway they are helpful also for 750/SS and 900/SS 1976 model keeping in mind that on these motorcycles the rear brake lever is on the right side and the gearchange lever is on the left side. Obviously in the last case speeds are reversed, viz: 1st gear down, while 2nd, 3rd, 4th and 5th are up. Fig. 24 shows the rear brake system in the 1975 model; you can see the A footlever, the B pump and the C caliper.

Bear in mind that insufficiently inflated tyres are detrimental to the roadholding qualities of the motorcycle, and cause a greater tyre wear and lower efficiency.

STOPPING THE MOTORCYCLE

To stop the vehicle, close the throttle completely (the engine will then act as a gentle brake), disengage the clutch and put the gear pedal in neutral. A slight use of the brakes will then stop the motorcycle.

To stop the engine, turn the contact key on the position « Arresto = Stop ».

MAINTENANCE

On good maintenance depends the good condition of the motorcycle.

By following these fundamental rules you can avoid serious troubles and obtain an excellent performance from your motorcycle.

The operations to be carried out are subdivided in accordance with the mileage run by the motorcycle. The recommendations which follow are, of course, merely indicative, because lubricating, checking and adjustments depend also on the nature of the road, the seasonal temperature, the length of the intervening period, etc.

At first 500 Km. (about 310 Miles)

- Restore the oil-level in the crankcase;
- Check the tyre pressure with a pressure-gauge;
- Tighten the cylinder head holding down bolts;
- Readjust the brakes and the wheel spokes;
- Check the clearance between valves and rockers for its correct value (see page 48);
- Adjust the chain and lubricate it.

At first 1000 Km. (about 620 Miles)

- **Totally replace the oil contained in the engine crankcase and the filter cartridge;** (see « Lubrication » at pages 14 to 17).
- Check the correct tension of the chain and lubricate it;

Check the clearance between valves and rockers as already explained.

Every 1000 Km. (about 620 Miles)

- Check the level of the oil contained in the engine crankcase;
- Check the correct tension of the chain and lubricate it.

Every 3000 Km. (about 1860 Miles)

- **Change the oil in the crankcase draining it while the engine is hot, make sure that the oil drains off completely;** every two oil changes, replace also the filter cartridge (see « Lubrication »).

Every 5000 Km. (about 3100 Miles)

- Remove the carburetor air filters and wash them by a blast of compressed air, in order to remove all impurities from the cloth.
- Clean out the carburetor float chamber, the main jet and the idle jet;
- Readjust the clutch because the wear on its linings might otherwise cause slip.
- Lubricate the hinge of the rear fork.
- Tighten uniformly the nipples of the spokes and check whether the screws and the nuts of the wheels have been firmly tightened.
- Verify the brake pads wear (see at page 56) and the pump fluid level.

Every 20,000 Km. (about 12,400 Miles)

- Dismantle the exhaust pipes and the cylinders, in order to remove the carbon deposits on the cylinder heads and on the pistons (this should be done by a Ducati Servicing Garage).

TAPPET ADJUSTMENT

The tappet adjustment, opening rockers, is made fitting a rocker shim of proper thickness on the valve stem end. Closing rocker adjustment, on the contrary, is made fitting a ring of proper thickness on the rocker, fixed by means of two half-rings which establish its position too.



Fig. 25

The working play between valves and rockers (cold engine) is as follows:

Opening rockers: INLET 0,13 EXHAUST 0,15

Closing rockers: INLET 0,00 EXHAUST 0,00

The play control is made by means of a feeler gauge (see Fig. 25).

DESMODROMIC DISTRIBUTION

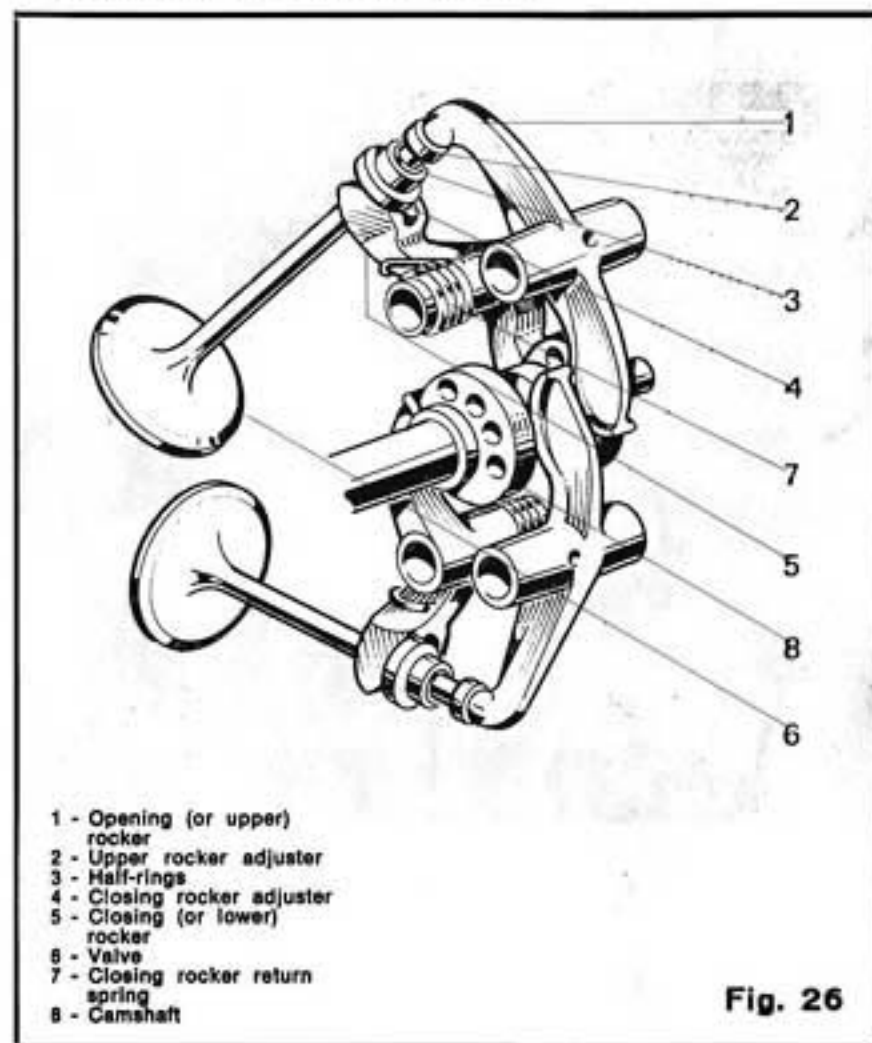

Fig. 26

ADJUSTMENT OF THE IDLING

When the engine is hot, adjust the 2 throttle stop screws (see Fig. 27) until each cylinder has an equal tickover. Then adjust the mixture screws to the position where you obtain the fastest tickover (see Fig. 28) approx 1 1/2 turns out. Then make equal turns on the 2 throttle stop screws until the tickover settles at 800/1000 r.p.m.

Note: The mixture screws should be turned in to weaken the mixture and out to richen the mixture.

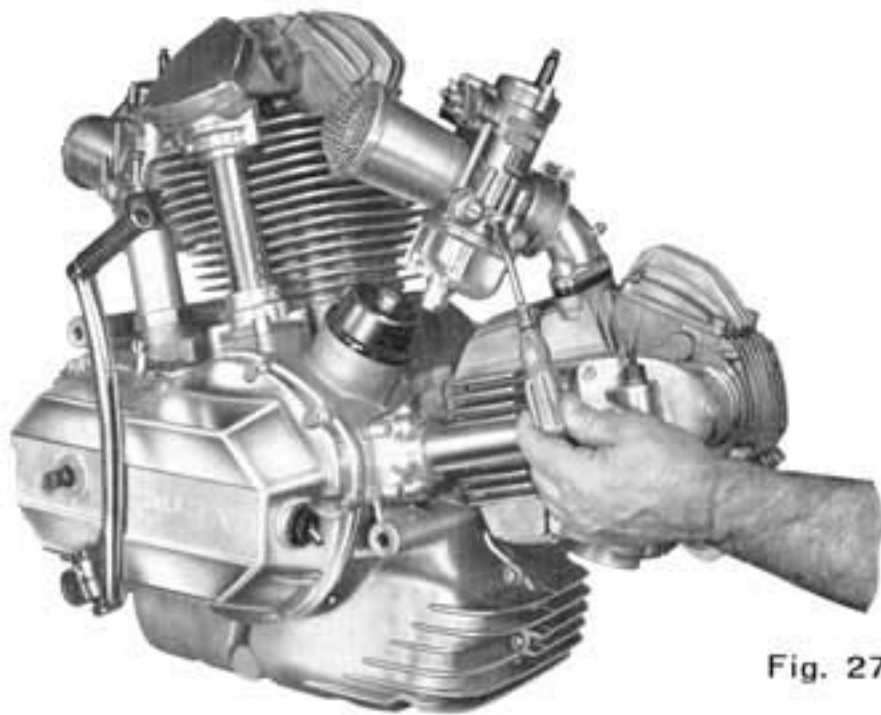

Fig. 27

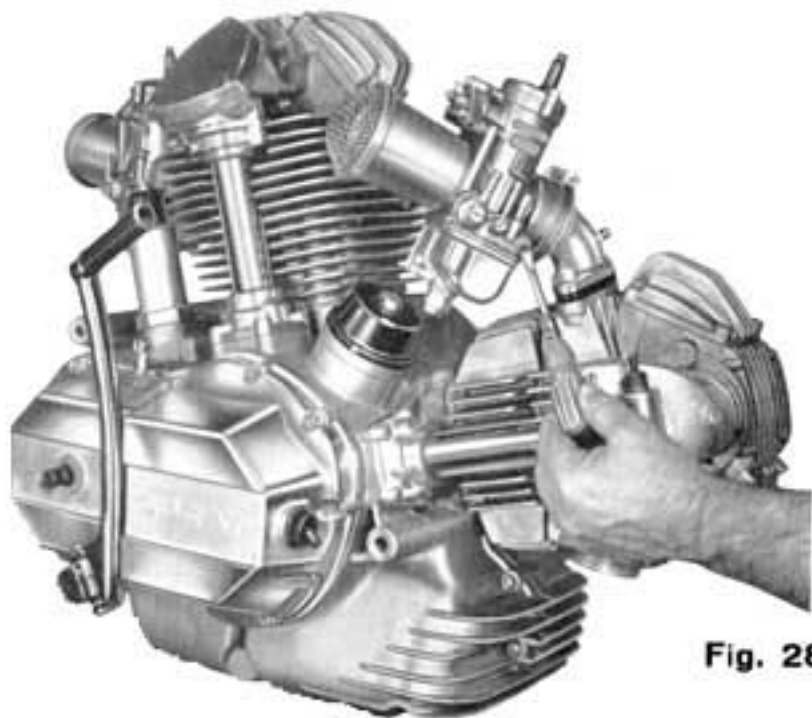

Fig. 28

HEADLAMP ALIGNMENT

It is advisable to check periodically the alignment of the headlight as follows:

- place the motorcycle at a distance of 5 metres (ft. 16.404) from a bright wall;
- make sure that the ground be even and that the optic axis of the headlamp be perpendicular to the wall;
- the motorcycle with its rider must rest on the wheels, not on the central stand;

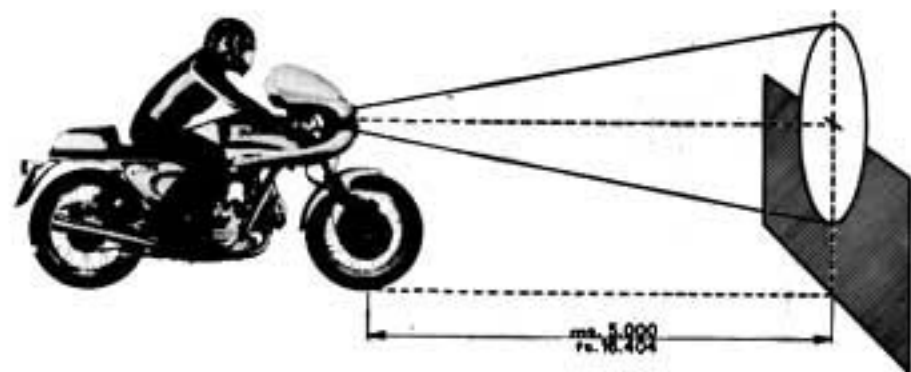

Fig. 29

- measure the height of the headlamp from the ground and trace a cross on the wall at the same height;
- when the depthlight is switched on the cross must be in the center of the circular light-beam hitting the wall;
- to rectify the alignment of the headlamp, operate by means of the two fixing screws of the headlamp on the front fork, or the screws of the head lamp ring.

CHAIN TENSION ADJUSTMENT

For the correct chain adjustment, up and down movements should be no more $15 \div 20$ mm. ($0.59'' \div 0.79''$), with grounded machine and one person sitting on the rear part of the saddle, or with rear suspensions at half-stroke (see Fig. 30).

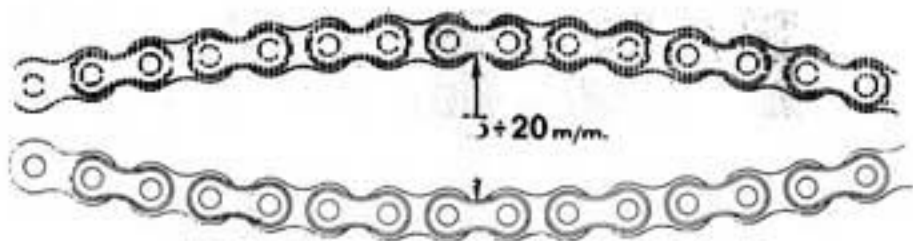

Fig. 30

OVERALL CLEANING

The motorcycle should be washed and cleaned periodically, according to the length of time it has been used and the state of the roads.

- Clean the engine with kerosene and wipe it dry with a clean rag;
- wash down the painted parts of the frame with water, using a sponge for washing and a shammy leather for drying;
- never use solvents, petrol, spirit or kerosene, otherwise the paint will look flat;
- grease the chromium plated parts with vaseline and polish with shammy leather;
- be careful not to wet the two transducers placed under the fuel tank, eventually dry them by a blast of compressed air and, if necessary, waterproof the cables with special adhesive as Silastic 732 RTV of Dow Corning Int. Brussels or equivalent.

PROLONGED REST OF THE MOTORCYCLE

If the motorcycle has to be put at rest for several months, it is advisable to proceed as follows:

- clean the motorcycle thoroughly;
- empty the petrol tank;
- take out the battery and keep it charged and efficient, as per instructions at pages 54-55;
- squirt through the holes of the sparking plugs several drops of oil into the cylinder and turn the engine by hand for several revolutions, distributing a thin oil film on the walls;
- put the motor upon a piece of wood, lifting the machine from the ground and empty the air out of the inner tubes;
- cover the machine with a canvas or water-proof cover.

INSTRUCTIONS FOR FITTING THE BATTERY ON THE MOTORCYCLE

— How to prepare the battery for the filling up:

Remove the gummed tape and the outlet plugs before filling up with electrolyte.

If the battery is provided with a long drain pipe, cut the sealed terminal at about 3 cm (1.18") from the end. If the battery has a short sealed tube and is provided with a long separate pipe, replace the short tube by the long one.

— Filling up with electrolyte

Fill up the battery; the electrolyte (diluted sulphuric acid) must have a density of 1.240 for tropical climates where the average temperature exceeds 25°C (77°F) and of 1.260 for mild climates.

Fill up to the UPPER LEVEL (level of the antisplash gauze) as it is indicated on the battery.

The electrolyte should have a temperature lower than 30°C (86°F) before the filling.

Leave the battery at rest for half an hour after having filled it up.

During this period, a part of the electrolyte can be absorbed: therefore it will be necessary to restore the level by adding more diluted sulphuric acid of the above specified densities.

Charge

We recommend to charge the battery for the first time before making it operating, if time and installation make it possible. Charge the battery with the current described in the Table, in a continuous manner, for 10 to 15 hours. If the level of the electrolyte is lower after the charge, pour DISTILLED WATER until restoring it, that is up to the UPPER LEVEL.

At the end of the charge, firmly secure the outlet plugs, eliminate the acid and water that may have overflowed, and dry the battery.

FITTING

- Firmly secure the battery on the vehicle.
- Correctly connect the wires to the battery, making sure not to commit any error, viz: Red wire to the positive pole and Black wire to the Negative pole.
- Do not bend or compress the drain tube of the battery. If the tube is compressed, there is the risk of an explosion.

BATTERY MAINTENANCE INSTRUCTIONS

Check the level of the electrolyte once a month. If it is lower than the average between the UPPER LEVEL and the LOWER LEVEL, pour distilled water until restoring the level.

Never fill to the brim with sulphuric acid.

Always keep the battery clean. Protect terminals with vaseline grease to avoid their corrosion.

Avoid bending and obstructing the drain tube.

RECHARGE

Recharge is necessary when lights and horn grow faint, and when the battery has been inactivated for more than one month.

If the vehicle is regularly used, the battery should never remain discharged for no reason whatsoever. If this occurs, check the regulator, alternator and in case the complete installation, including of course, the battery which could be in bad condition.

To recharge the battery, follow the hereunder Table. Charge until the battery starts boiling and the specific weight of the electrolyte exceeds 1.240 in tropical climates and 1.260 in the mild ones.

Type of battery	Tension (Volt.)	Capacity in 10h (Ah)	Recharge current (A)	Recharge hours
12N-12A-4A	12	12	1,2	10

INSTRUCTIONS FOR THE MAINTENANCE OF THE ELECTRICAL SYSTEM

In case of inspections or repairs, it is extremely important to know the working of the electrical system and to follow with care the wiring diagram. To avoid demagnetizing the rotor, be careful to never send electrical current of the battery to the alternator.

(Do not connect the battery with inverted poles).

Every inspection should be made with convenient Ohmmeter, Voltmeter and Ammeter.

In case the electronic regulator does not work, do not tamper it for any reason, but send it to DUCATI MECCANICA S.p.A. for replacement.

PERIODICAL MAINTENANCE OF THE BREMBO DISC BRAKES.

To have the hydraulic brakes efficient, follow scrupulously these recommendations:

- frequently check the fluid level in the pumps; it must never be more than 8 mm. (0.315") below the maximum level;
- periodically check (for instance every 5,000 Km. = 3,100 Miles) the fluid overflow; exclusively use the brake fluid (SAE J 1073 c) AGIP F1 BRAKE FLUID SUPER HD or Equivalent taken from the original tin;
- every 20,000 Km. (12,400 Miles) it is advisable to completely replace the fluid;
- take care that the brake fluid does not get in touch with the motorcycle paint because it would be damaged;
- for a good working of the brake, take care that the tubes be always full with the fluid, and without air bubbles. The presence of air causes spongy and long travel in the hand lever.

Attention!

For a good maintenance of the two disc brakes apply to a DUCATI Service Station.

REPLACEMENT OF THE FRICTION PADS

Every 5000 Km. (3100 Miles) it is advisable to check if the pads are worn out.

For this operation apply to a DUCATI Service Station. Proceed in the following manner:

- take out the central pin and its flat spring;
- pull out the two pad retaining pins;
- pull out the pads.

The thickness must be:

with new pad: mm. 9 (0.354");

at the wear limit: mm. 5.5 (0.217").

If the thickness is lower than the wear limit, the pads have to be replaced. The friction material must not be

utilized till the metal plate appears, as this would heavily damage the disc and moreover the minimum coat of friction material assuring the thermic insulation between pads and brake fluid would be missing. To replace the pads, act as follows:

- push the small pistons inside the half-calipers, avoiding damage to the dust covers;
- fit the new pads in the caliper;
- fit the stop pins, the peg and position spring.

















Acting as explained hereupon, it is not necessary, after the pads have been replaced, to drain the system, but only to press several times the brake lever till the small pistons revert to their normal position (pads at about 0,2 mm. (0.0079") from the disc).

ATTENTION! During the replacement of the pads, it is advisable to take some fluid out of the reservoir, because the piston backing in the cylinders, could let the fluid overflow from the reservoir.

IMPORTANT: for about 100 Km. (60 Miles) it is advisable to cautiously act on the new pads, allowing the friction material to correctly and entirely bed in.

SPECIAL TOOLS FOR SERVICING GARAGES

SPECIAL TOOLS FOR SERVICING GARAGES

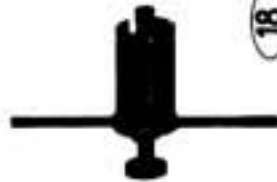
LEGEND

- 1) 98112.0002 Protractor wheel (X A).
- 2) 88713.0101 Clutch bell and drum locking wrench (A).
- 3) 88713.0102 Valve and spring disassembling and reassembling tool (A).
- 4) 88713.0104 Tabular wrench for chain pinion locking ring (A).
- 5) 88713.0107 Pinion retaining wrench for ring locking (For pinion Z = 16) (A).
- 6) 88713.0108 Alternator retaining wrench for nut locking (A).
- 7) 88713.0112 Graduated disc bearing tool for advance checking (A).
- 8) 88713.0113 Spanner for removing exhaust pipe ring (A).
- 9) ——— Obsolete.
- 10) 88713.0116 Advance checking indicator with stroboscopic light.
- 11) 88713.0117 Puller to remove ignition generator unit.
- 12) 88713.0118 Pinion retaining wrench for locking rim (Pinion Z = 15).
- 13) 88713.0119 Drift for electronic ignit. generator timing.
- 14) 88713.0120 Rocker pin extractor.
- 15) 88713.0258 Clutch cover extractor (X A).
- 16) 88713.0262 Rocker assembling pin (X A).
- 17) 88713.0263 Timing shaft removing wrench (X A).
- 18) 88713.0270 Bearing extractor (X A).

(X) Equal to those of the single shaft motorcycles.
 (A) Equal to those for twincylinder 750 engine.

LOCATING AND REMEDYING FAULTS

The following list contains several of the most frequent faults which may arise and advice on remedying them.

ENGINE DOES NOT START EASILY

First of all, ascertain that there is enough petrol and that the cock is turned on (A = open; R = reserve). If these are in order, the fault may be one or more of the following.

CAUSE	REMEDY
Petrol pipes are clogged.	Blow through them until the obstacle is removed.
Petrol filter is dirty.	Dismantle the filter and clean the gauze by an air blast.
Petrol cock filter is dirty.	Dismantle the filter and clean it by a blast of air through the gauze.
Carburetor float stuck.	Remove the float and clean out the float chamber (this should be done by a DUCATI Servicing Garage).
Carburetor float leaking.	Change the float (at a DUCATI Servicing Garage).
Jet is clogged.	Remove the obstacle by a strong blast of air.
The cable from the transducer to the spark plug is broken or sparking externally.	Inspect the cable insulation for faults and if necessary change the cable at a DUCATI Servicing Garage.

CAUSE

REMEDY

Defective sparking plugs.	Change or clean the plug, making sure that the insulating core is not damaged, that there are no carbon deposits on the electrodes and that the spark gap does not exceed 0.8 mm. (0.0315").
Compression lacking.	Check if the sparking plug has been tightly screwed in, check the valves for gas-tightness and the tightness of the piston rings (at a Ducati Servicing Garage).
A valve spring is broken.	Change the broken spring (at a Ducati Servicing Garage).
Valve sticking.	Dismantle the valve, clean the valve stem and the bore of the valve guide, and make sure that the clearance between stem and bore does not exceed 0.08 mm. (0.0032") (at a Ducati Servicing Garage).
No sparks in the sparking plugs.	Check that the key switch is not defective, in such case it could keep earthed the two transducers. In fact this switch feeds the full system and the « stop engine » relay too and in case this is not excited, the two green wires of transducers remain earthed. Check that the cables connecting the ignition generator with the two transducers be well connected and that there is no damp between them and among them and the earth.

CAUSE	REMEDY
One spark plug has no sparks.	<p>Check that the «stop engine» relay is not defective, since it could keep the two transducers earthed.</p> <p>If no faults will be found, replace the stator base and in case, the transducers (at a DUCATI Service Garage).</p> <p>Check that the cables connecting the ignition generator with the relevant transducers, are well connected and that there is no moisture between them and between them and the earth.</p> <p>Check that the «stop engine» relay is not defective, since it could keep one of the transducers earthed.</p> <p>If everything is correct, try to replace the relevant transducer and in case also the stator base of the generator (at a Ducati Service Garage).</p>

LIGHTS ARE NOT WORKING REGULARLY

CAUSE	REMEDY
The battery is discharged or discharges frequently.	<p>Check the condition of the battery and the recharge circuit.</p> <p>Check the regulator (at a Ducati Service Garage) and if defective, it must be replaced, being impossible to repair it.</p> <p>Once the fault has been found, let recharge the battery.</p>

CAUSE	REMEDY
With key not inserted, battery discharges quickly.	<p>To check the recharge current, act as follows: Disjoin the wire from the + terminal block of the battery.</p> <ul style="list-style-type: none"> — Insert an amperemeter in direct current between the terminal clamp and the wire (possibly with central «0»). — Let the engine turn, till attaining 5,000 r.p.m. The amperemeter should show: <ul style="list-style-type: none"> a) maximum current about ~ 10 A, with completely discharged battery. b) minimum current about ~ 1 A, with almost completely charged battery. <p>According to the battery load condition, you will obtain intermediate figures.</p> <p>These tests must be carried out with switched out headlight.</p> <p><i>Attention! The amperemeter must be always inserted with still engine.</i></p> <p>Checking the Electrical System.</p> <p>Make sure that all the bulbs are efficient.</p> <ol style="list-style-type: none"> 1) With the lights switched out (during the day), the amperemeter should read 0 at 1,000 r.p.m. approx. 2) With town lights switched on (during the night) the amperemeter should read 0 at 1,200 r.p.m. approx. 3) With the antidazzle lights switched on (during the night) the amperemeter should read 0 at 2,200 r.p.m. approx. (in a Ducati Service Garage). <p>Check if there are earthed contacts in the system.</p>

INEFFICIENT ENGINE

CAUSE	REMEDY
Irregular feed of petrol to the carburetor.	Clean the carburetor filter, the petrol cock filter and the petrol pipe.
Main jet partly clogged.	Clean the main jet by means of an air blast.
Carburetor butterfly valve does not open completely.	Readjust the valve travel by means of the adjustment screw of the carburetor Bowden cable (at a Ducati Servicing Garage).
The float needle does not close properly.	Clean out the carburetor and especially the needle seat (at a Ducati Servicing Garage).
Petrol of bad quality.	Empty the petrol tank and refill at a reliable garage.
The spark plug is not of the right type.	If the sparking plug overheats, you will have preignition, knocking and misses, especially at high revs. If the sparking plug remains too cold, you will have no ignition, because the electrodes will short-circuit. Use the right type of sparking plug; we advise the use of a plug having a thermal figure of 260 of the Bosch international scale.
The plug is loose in its adaptor.	Tighten the plug down well. A washer should always be placed between the sparking plug and its seating in the cylinder head.
One sparking plug cable sparks externally.	Change the cable or repair the insulation (at a Ducati Servicing Garage).

CAUSE

REMEDY

The gap between the electrodes of the sparking plug is too wide.	Adjust the gap to the proper width of about 0.8 mm. (0.0315").
The spark plug electrodes are dirty.	Clean the electrodes with a wire brush.
One transducer is defective.	Replace it at a Ducati Service Station.
The stator base of the electronic generator is defective.	Replace it at a Ducati Service Station.
The silencers are almost completely clogged-up.	Clean the silencer, to ensure the free discharge of the spent gases.

INDEX

GUARANTEE CARD	Page 2
FOREWORD	5
Ducati Servicing Garage	6
Orders for spare parts	6
IDENTIFICATION NUMBERS	7
PRECAUTIONS TO BE FOLLOWED DURING THE INITIAL RUNNING-IN PERIOD	8
ENGINE MAIN SPECIFICATIONS	10
Engine data	10
Air cooling	11
Timing	11
Timing adjustment	12
Petrol feed	13
Lubrication	14
Engine	14
Filter cartridge	15
Lubrication system	16
Suggested lubricants	17
Centrifugal oil filter	17
Electronic ignition system	18
Ignition generator	18
Transducers	20
Relay to stop the engine	20
Spark plugs	21
Advance checking	21
Transmission	23
Example of speed calculation	24
VEHICLE MAIN SPECIFICATIONS	26
Frame	26
Front suspension	26
Wheels	26
Rear suspension	27
Fork fulcrum spindle	27
Silencer homologation	28
Brakes	28
Saddle	29
ELECTRICAL EQUIPMENT - Lights and controls	30
Headlamp	30
Dashboard	30
Horn	30

Stop lamp switches	31
Key switch	31
Fuse box	31
Battery	32
Regulator	32
Alternator	33
Plate-holder	33
Controls on the handlebar	33
Direction flashers	33
Some advantages of the electric equipment with electronic regulator	34
Wiring system operation	34
Controls	36
CONTROL SCHEME	37
OVERALL DIMENSIONS AND WEIGHTS	39
TOOLBOX	40
PERFORMANCES	41
HOW TO USE THE MOTORCYCLE	42
Filling up and starting of the cold engine	42
Stopping the motorcycle	45
MAINTENANCE	46
At first 500 Kms. (310 Miles)	46
At first 1000 Kms. (620 Miles)	46
Every 1,000 Kms. (620 Miles)	47
Every 3,000 Kms. (1860 Miles)	47
Every 5,000 Kms. (3100 Miles)	47
Every 20,000 Kms. (12,400 Miles)	47
Tappet adjustment	48
Desmo distribution	49
Idling adjustment	49
Headlamp alignment	51
Chain tension adjustment	52
Overall cleaning	52
Prolonged rest of the motorcycle	53
Instructions for fitting the battery	53
Battery maintenance instructions	54
Electrical system maintenance	55
Brembo disc brakes periodical maintenance	56
Replacement of the friction pads	56
SPECIAL TOOLS FOR SERVICING GARAGES	60
LOCATING AND REMEDYING FAULTS	62
Engine does not start easily	62
Lights are not working regularly	64
Inefficient engine	66