

DUCATI

5 - speed
250 cc. over head cam-shaft
MOTORCYCLES 196

Distributor for USA
BERLINER MOTOR CORPORATION

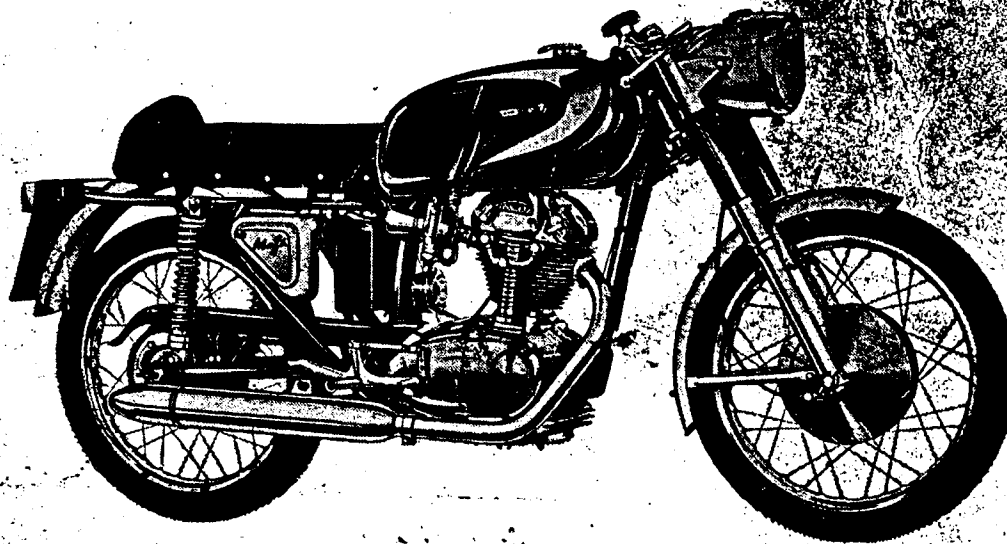

Instructions for use
and maintenance

MK III TUNING SPECS

Valve clearances: .006" intake (.15 mm)
.017" exhaust (.30 mm)

Ignition:

Breaker points .017-.015" (.3-.4 mm)

Advance 21°-23° static

18° automatic

39°-41° total @ 3000 r.p.m.

spark plug gap .020" (.5 mm)

5 - speed over head cam-shaft

DUCATI

MOTORCYCLES **196**

250 GT

250 monza

250 mach 1

250 mark III

250 motocross

SPECIFICATIONS - USE - MAINTENANCE



1 st. ISSUE - PRINTED DM - Mod. 751/E December 1964 - 10.000

Every Motorcycle receives one copy of the present booklet.

G U A R A N T E E C A R D

Every DUCATI MOTORCYCLE is supplied with a « Guarantee Card » which will be found in the sealed tool box.

The seal may be broken only by the purchaser.

The contents of this booklet are not binding and though the main specifications of the motorcycle described and illustrated in this booklet remain unchanged, the DUCATI MECCANICA S.p.A. will be free to introduce modifications of some details, or of some accessories, if these modifications will be judged necessary, or if they can improve the motorcycle, or finally for some technical-economical exigencies, but without being obliged to bring this booklet up-to-date.

Dear Sir,

We are very glad to welcome you among our clients, and feel sure that you will not fail to appreciate the magnificent performance of the DUCATI Motorcycles.

The magnificent performance and reliability of our machines reflect the experience gained throughout many years of successful racing both on track and road.

In order to obtain the fine service that the Ducati machine is capable of giving, it is essential that the instructions contained in this book be religiously adhered to.

If these instructions are followed closely, particularly during the running-in period of the machine then you will be assured of many years trouble-free enjoyable riding.

We thank you for your patronage and congratulate you on your wise choice of such a fine machine with its unequalled performance.

DUCATI MECCANICA S.p.A.

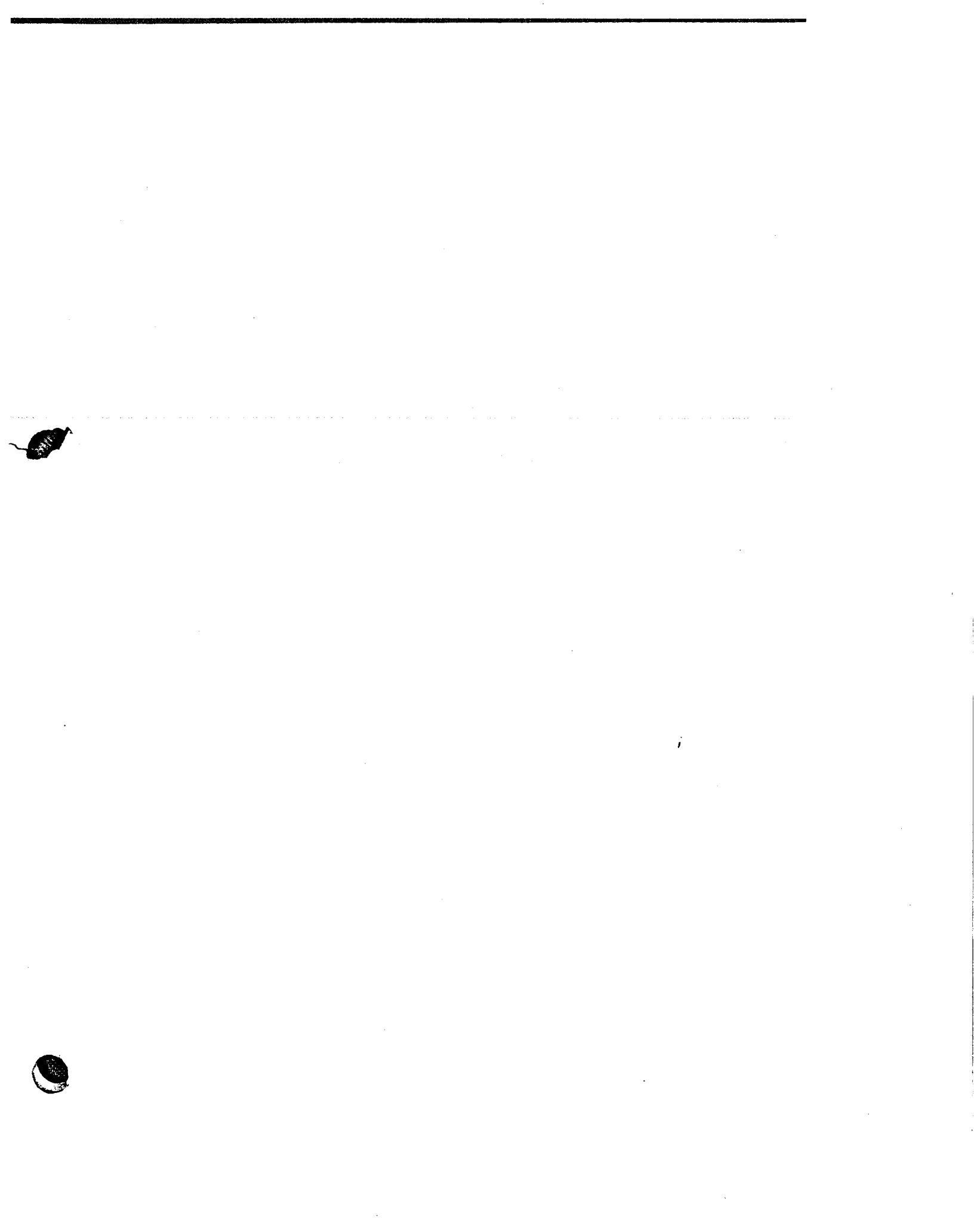

MOTORCYCLE DUCATI 250 GT

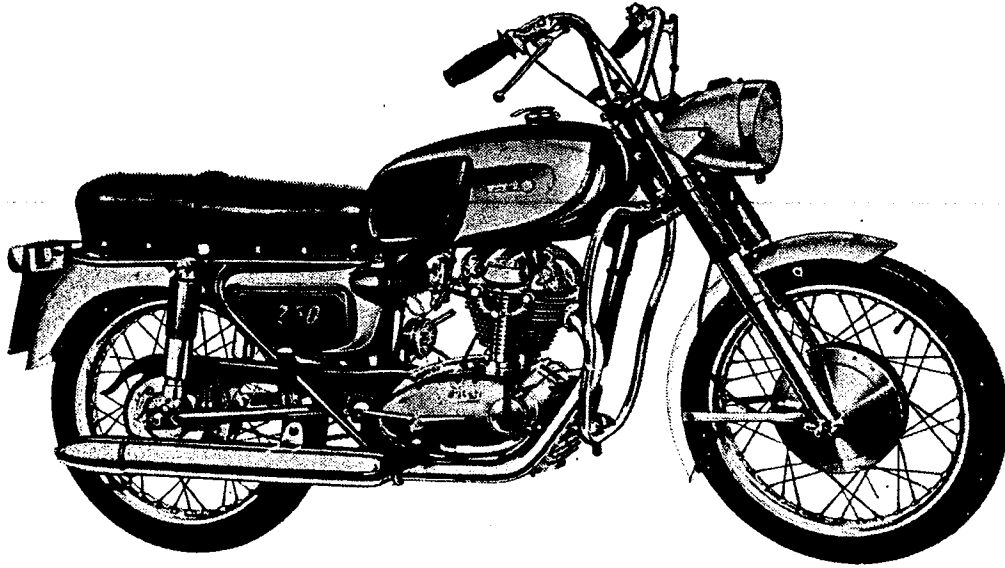

Colours: bright black and metallized aluminium

MOTORCYCLE DUCATI 250 MONZA

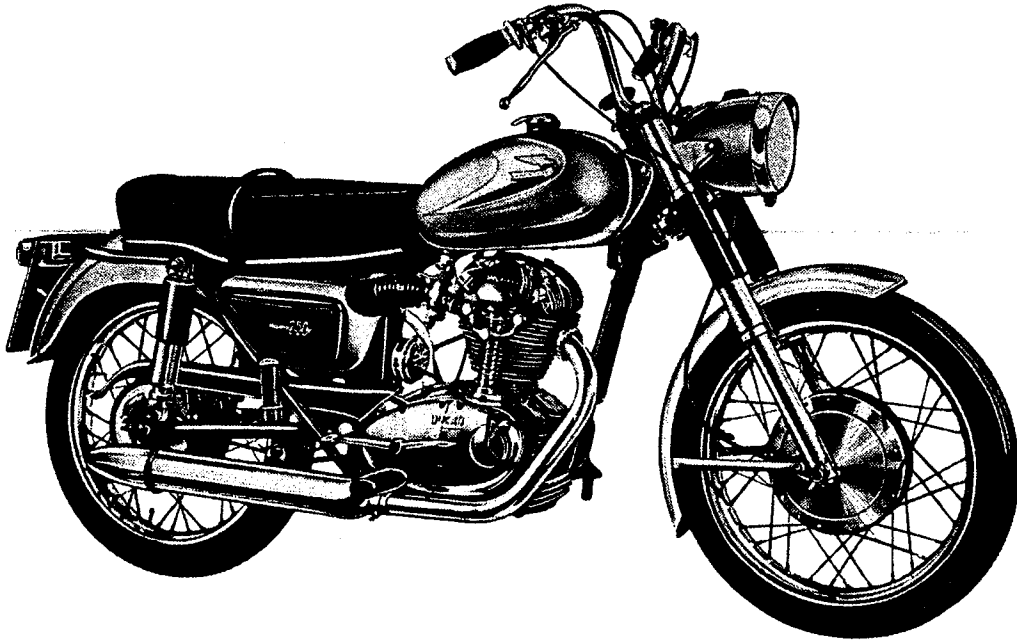

Colours: bright black and metallized aluminium

MOTORCYCLE DUCATI 250 MACH 1

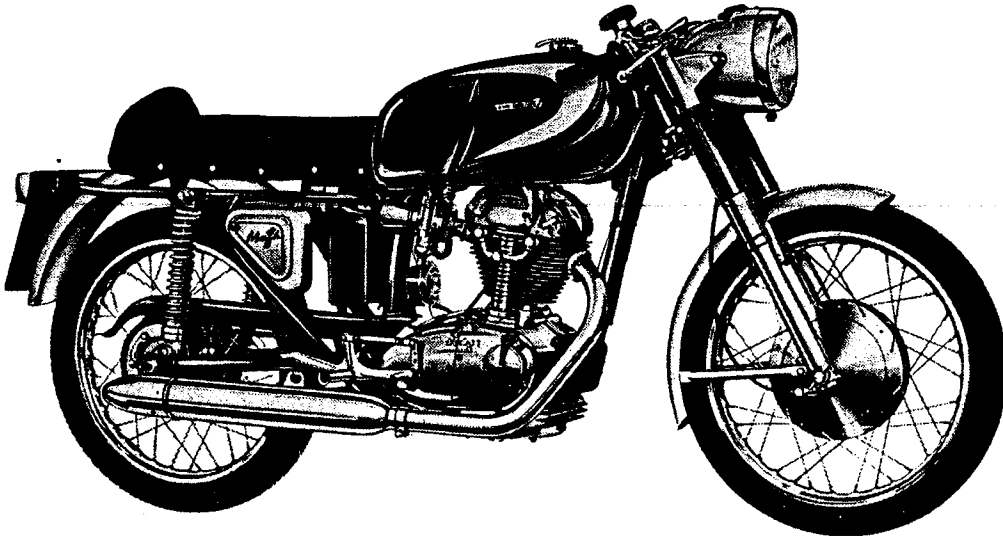

Colours: Triumph red and metallized aluminium

MOTORCYCLE DUCATI 250 MARK III

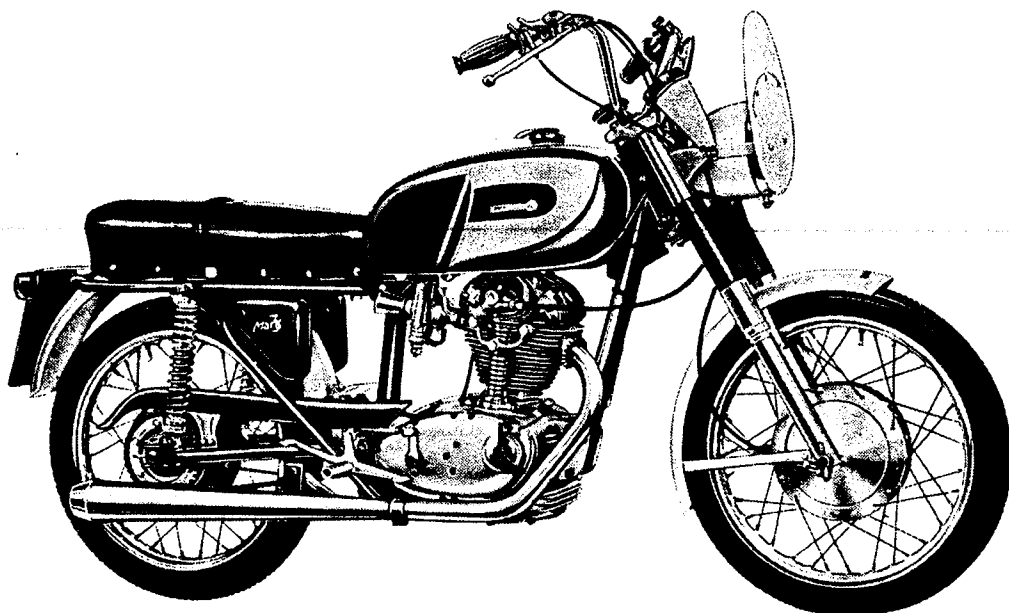

Colours: bright black and metallized aluminium

MOTORCYCLE DUCATI 250 SCRAMBLER

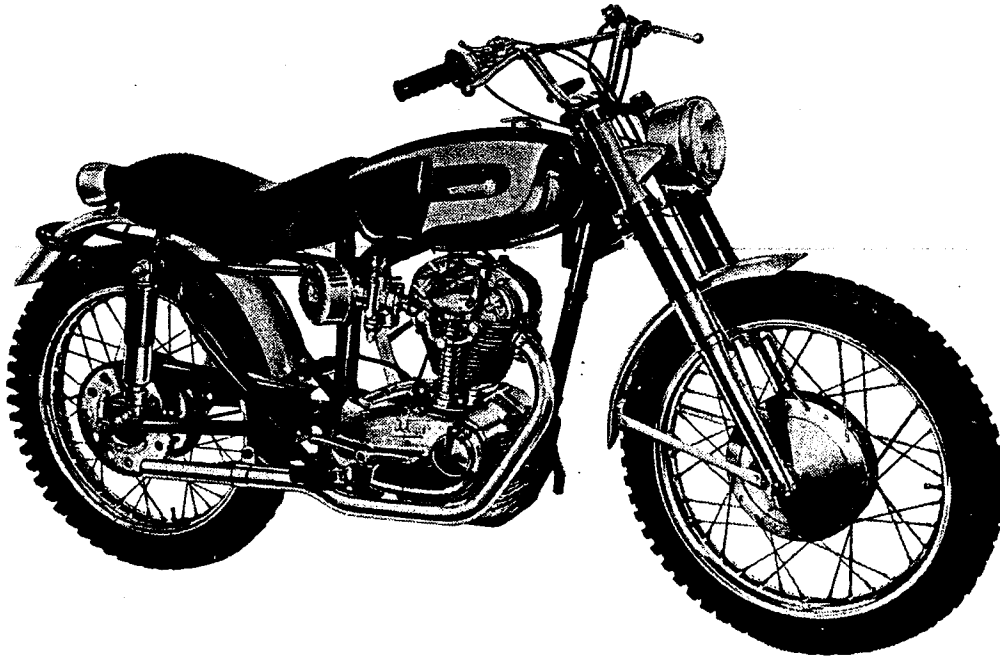

Colours: bright black and metallized aluminium

A FOREWORD

The main goal of the present instruction booklet is to enable the owner of an over head cam-shaft DUCATI Motorcycle to use his vehicle in the best possible way.

The following notices are therefore only simple recommendations, suggestions, advices, and terms of reference, sufficient to enable anyone, having no experience or ignoring any special technical knowledge, to use his vechicle and to maintain it for a long time in perfect working condition.



DUCATI SERVICING GARAGE

It is advisable when taking the machine to a garage for repairs to ensure that the garage is a Ducati agent as the staff will have been specially trained and the garage will have been equipped with the necessary tools to carry out any repair required. They will also carry a full stock of genuine Ducati spares.

SPARE PARTS

It is absolutely necessary that each order for spare parts clearly states the following data:

- 1) The catalogue code of the spare part (obtained from the Spare Parts Catalogue of the model wanted).
- 2) Serial number of the engine (when ordering spare parts of the engine).
- 3) Serial number of the frame (when ordering spare parts of the frame).

IDENTIFICATION NUMBERS

Every DUCATI over head cam-shaft motorcycle can be identified by its frame and engine serial number.

The same serial number is stamped on the central girder near the battery.

The engine serial number is stamped on the crankcase near the front connection between the engine and the frame.

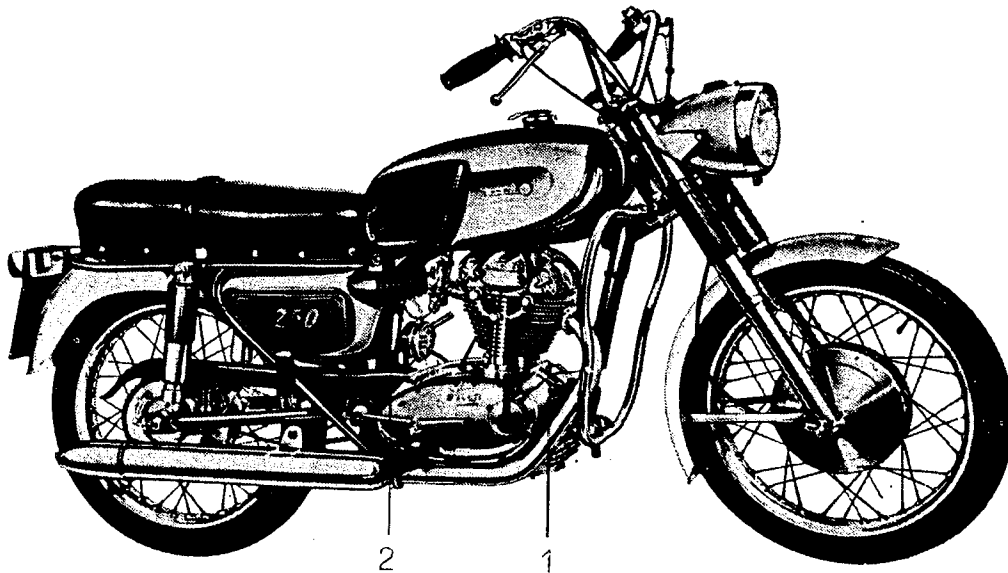

1 - Engine serial number

2 - Frame serial number

PRECAUTIONS

to be followed during the initial running-in period

The modern engine construction calls for very close tolerances between moving parts. It is essential that care is exercised during the running-in period, a process which has already been started by the factory. The engine should never be over-revved or allowed to « slog » during this time and recommended maximum speeds in gears should be strictly observed.

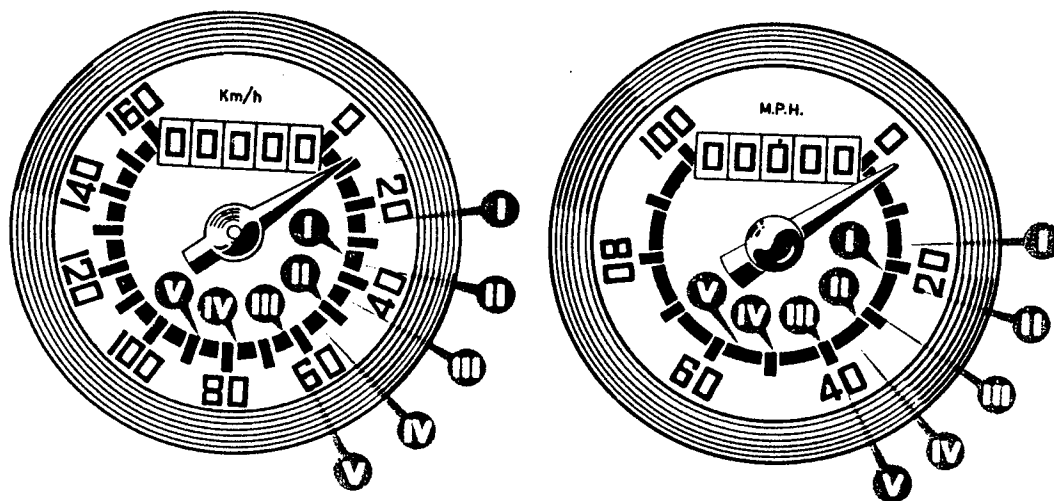

DISTANCE TRAVELLED	MAXIMUM SPEED IN MILES AND KMS. PER HOUR				
	in bottom gear	in 2nd speed	in 3rd Speed	in 4th speed	in top speed
Up to 300 miles	16	22	29	36	40
Up to 500 Km.	25	36	46	56	64
From 300 to 600 miles	21	31	40	49	56
From 500 to 1000 Km.	34	50	64	79	90

It is advisable to change the oil first at 300 miles and then at 600 miles (with the engine warm). Re-adjust the tappets, regulating the adjusting screw in the 250 GT and MONZA, fitting the rocker appropriate shim in the other 3 models; tighten cylinder head and holding nuts, crankcase nuts and screws. Do not overtighten as damage may result in thread stripping or bolts breaking. Readjust contact breaker.

In order to ensure careful running-in the carburetor has been fitted with a distance piece which restricts the full use of the accelerator. After 600 miles this should be removed by your Ducati dealer.

Failure to comply with the above recommendations absolves the manufacturer from all liability of guarantee and any damage that may result.

MAIN SPECIFICATIONS

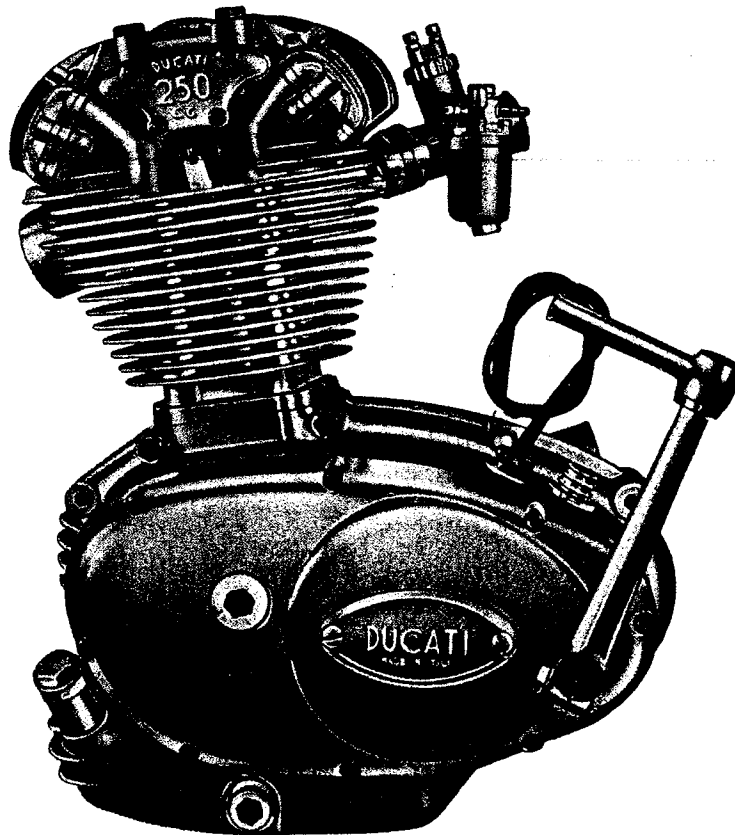

ENGINE

- Single cylinder, four stroke, with cylinder inclined forward 10° from the vertical. The engine is supported by a cradle formed frame.
- bore: 74 mm. (2.9134")
- stroke: 57,8 mm. (2.27559")
- cylinder capacity: 248,589 c.c. (15.1698 cu.in.)
- compression ratio: 8 : 1 for the 250 GT and Monza, 10 : 1 for 250 MACH 1 and Mark III, and 9.2 : 1 for 250 SCRAMBLER;

- combustion chamber with hemispherical ceiling;
- cylinder barrel of light alloy, deeply finned and with inserted special cast-iron liner;
- connecting rod of special steel with big-end assembled on a cage roller bearing and little-end bushed to take the gudgeon pin;
- pistons of light alloy, convex topped and in one piece, with four piston rings, two of which are slotted oils scrapers;
- cylinder head cast in light alloy and closely finned with inserted valve seats.

TIMING

The timing system is provided with overhead valves, inclined at 80° timed by an overhead camshaft. The valves are made of special steel.

250 GT and MONZA

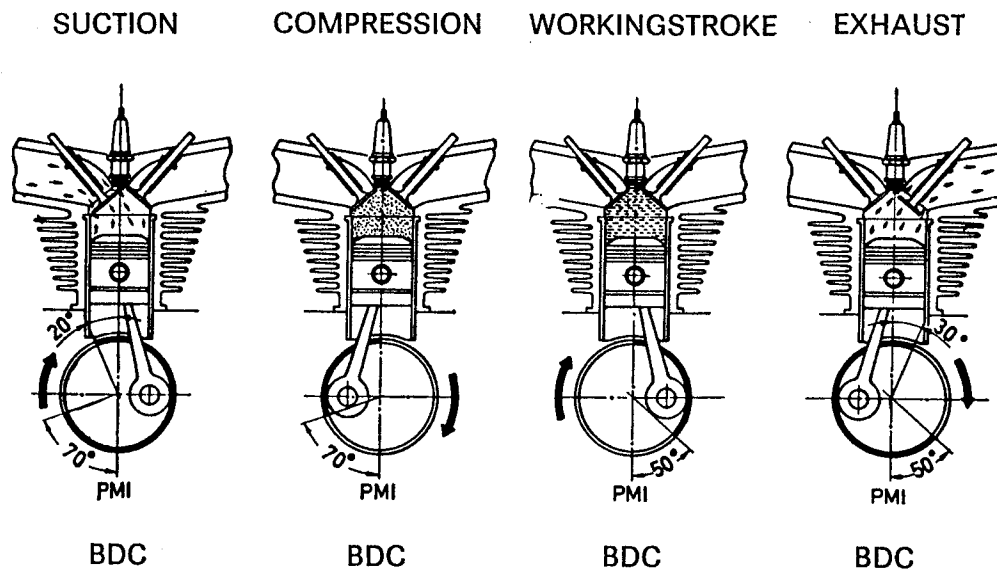

Specifications

The timing values, with a clearance of 0.20 mm. (0.0079") between the valve and the rocker are the following:

Valve	Opening $\pm 5^\circ$	Closing $\pm 5^\circ$
Suction	20° before TDC	70° after BDC *
Exhaust	50° before BDC	30° after TDC **

* BDC = Bottom dead center.

** TDC = Top dead center.

250 MACH 1 and MARK III

SUCTION

COMPRESSION

WORKINGSTROKE

EXHAUST

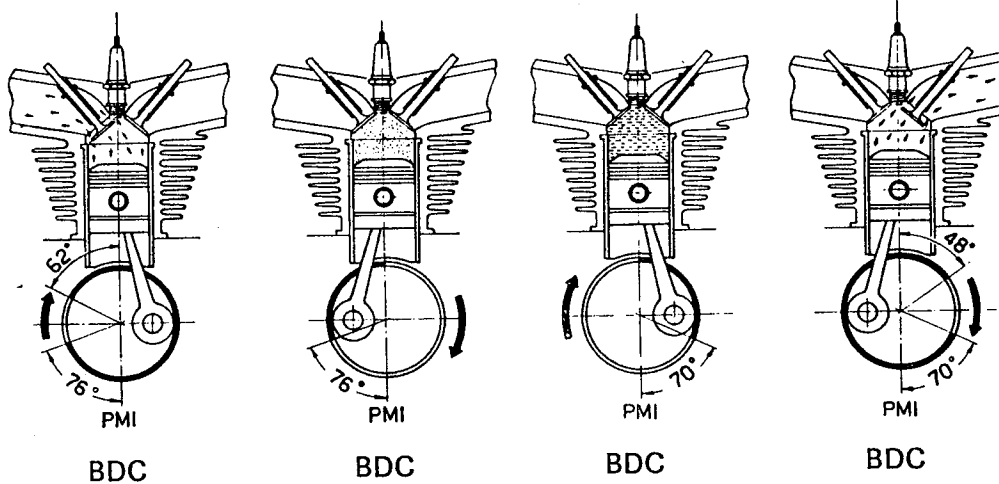

Timing, with a clearance of 0.15 mm. (0.0059 in.) between the valve and the suction rocker and 0.30 mm. (0.0118 in.) between the valve and the exhaust rocker, are as follows:

Valve	Opening $\pm 5^\circ$	Closing $\pm 5^\circ$
Suction	62° before TDC	76° after BDC *
Exhaust	70° before BDC	48° after TDC **

* BDC - Bottom dead center.

** TDC - Top dead center.

250 SCRAMBLER

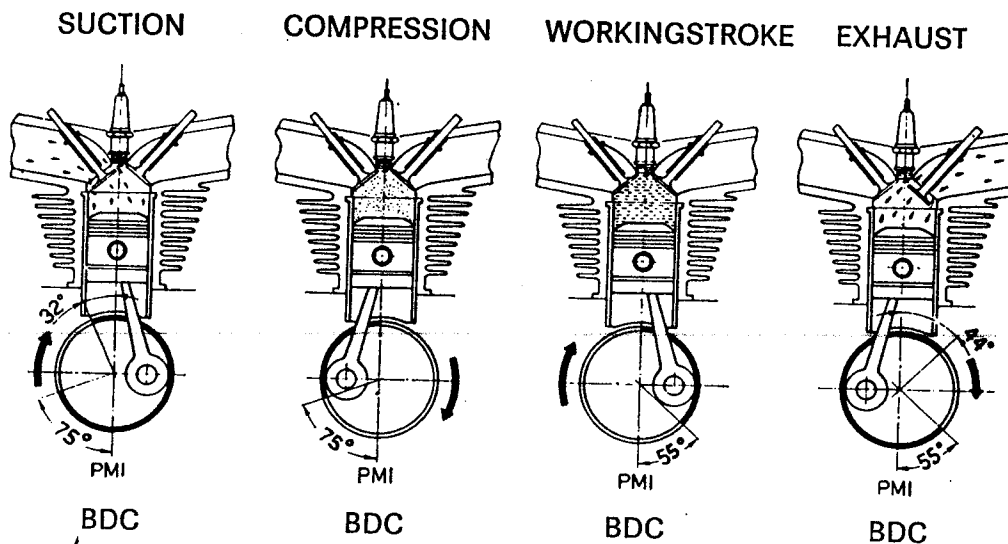

Timing with a clearance of 0.15 mm. (0.0059 in.) between the valve and the suction rocker, and 0.20 (0.0079 in.) between the valve and the exhaust rocker are as follows:

Valve	Opening $\pm 5^\circ$	Closing $\pm 5^\circ$
Suction	32° before TDC	75° after BDC*
Exhaust	55° before BDC	44° after TDC**

* BDC - Bottom dead center.

** TDC - Top dead center.

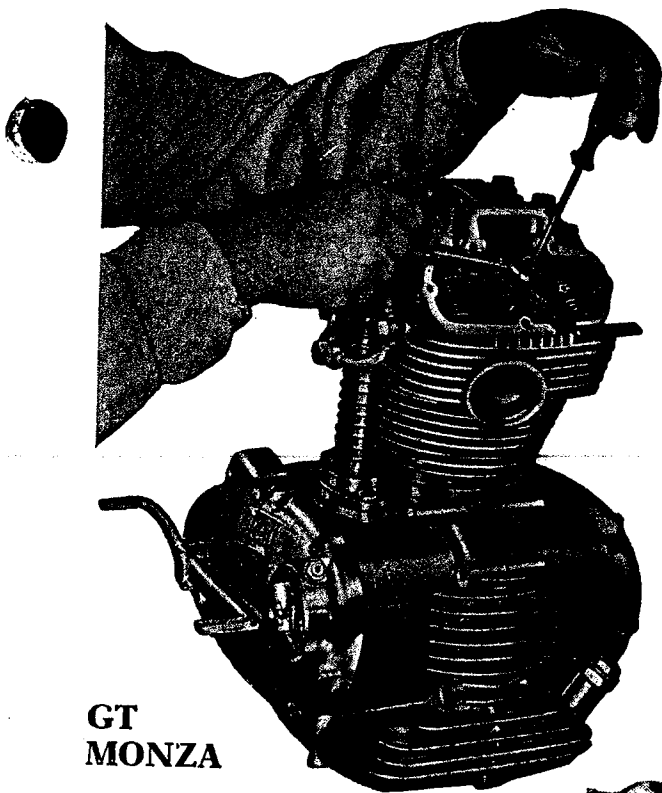

**GT
MONZA**

Clearance

The working clearance between valves and rockers, when the engine is cold, is of 0.05 (0.0020") to 0.07 mm. (0.0028") for the 250 GT and Monza; 0.15 mm. (0.0059") respectively 0.30 mm. (0.0118") between valve and suction and exhaust valve, for the 250 MACH 1 and Mark III; respectively 0.15 mm. (0.0059") and 0.20 mm. (0.0079") for the SCRAMBLER. The clearance has to be adjusted and checked with a feeler gauge, after the said timing data have been controlled.

Adjustment

The tappets are adjusted by means of the adjustment screws on the rockers in the 250 GT and Monza and the appropriate rockers shim on the end of the valve stem on the other models.

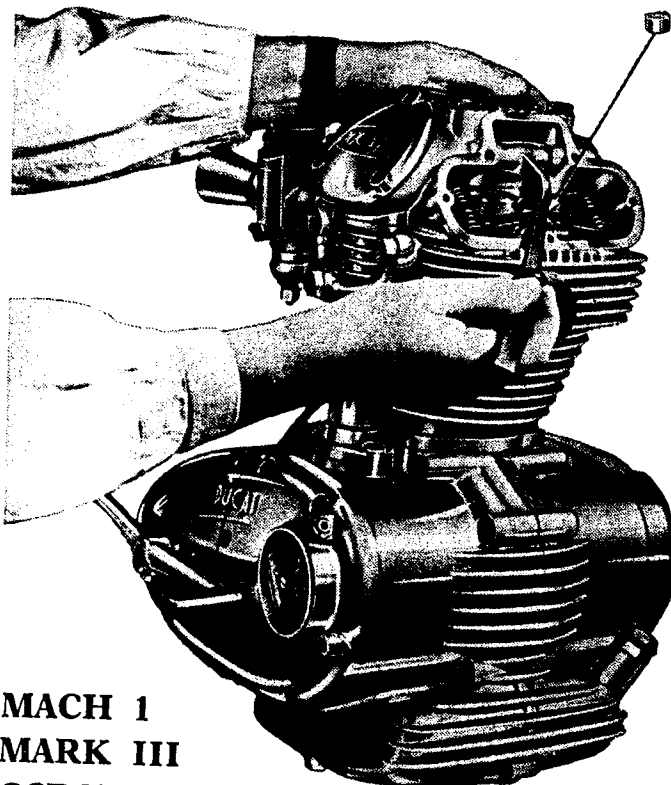

**MACH 1
MARK III
SCRAMBLER**

Engine timing

The timing gears in the crankshaft and on the camshaft, are provided with reference marks engraved on the toothed periphery.

The engine is timed when the above mentioned marks are disposed as indicated by the arrows in the following illustration.

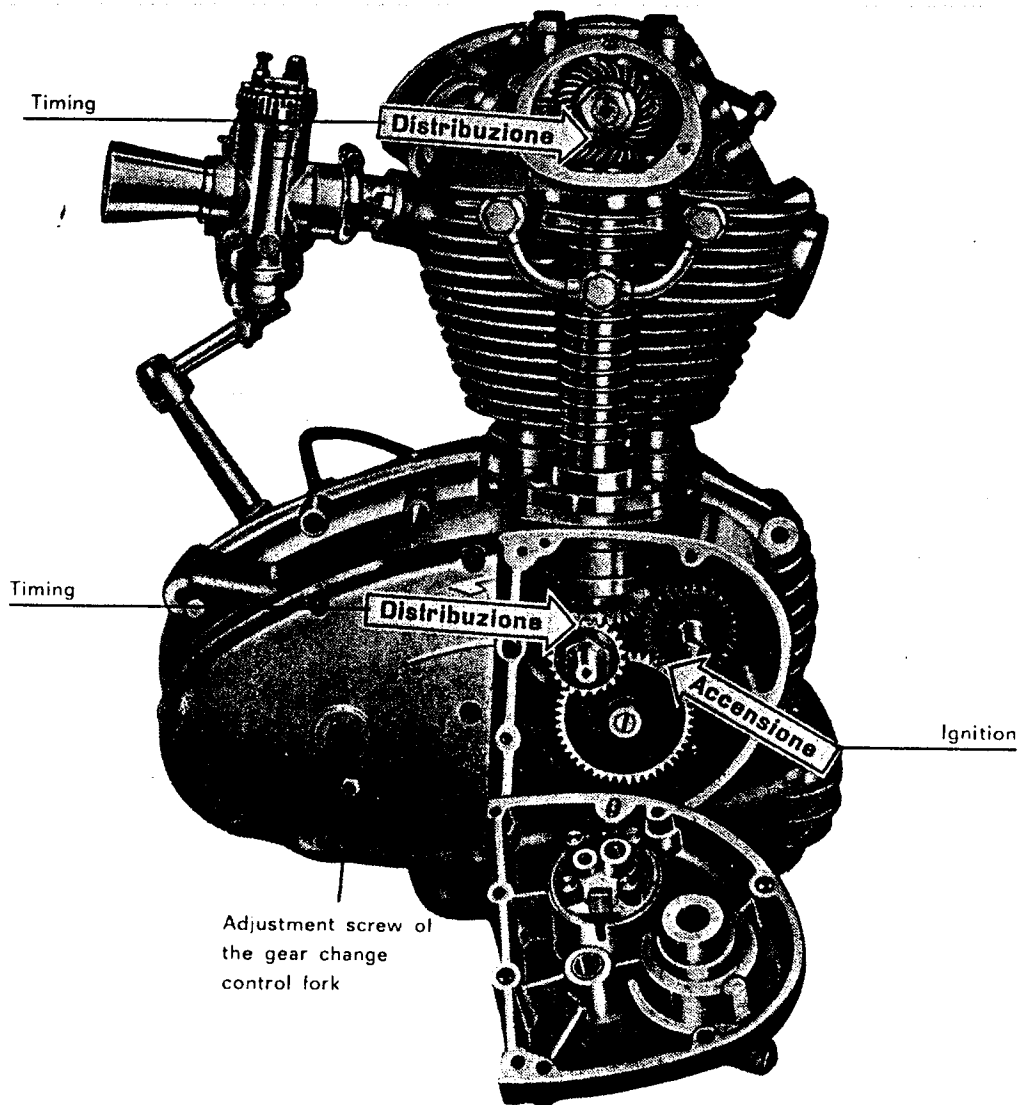

**GT
MONZA**

**Adjustment
of minimum
air intake**

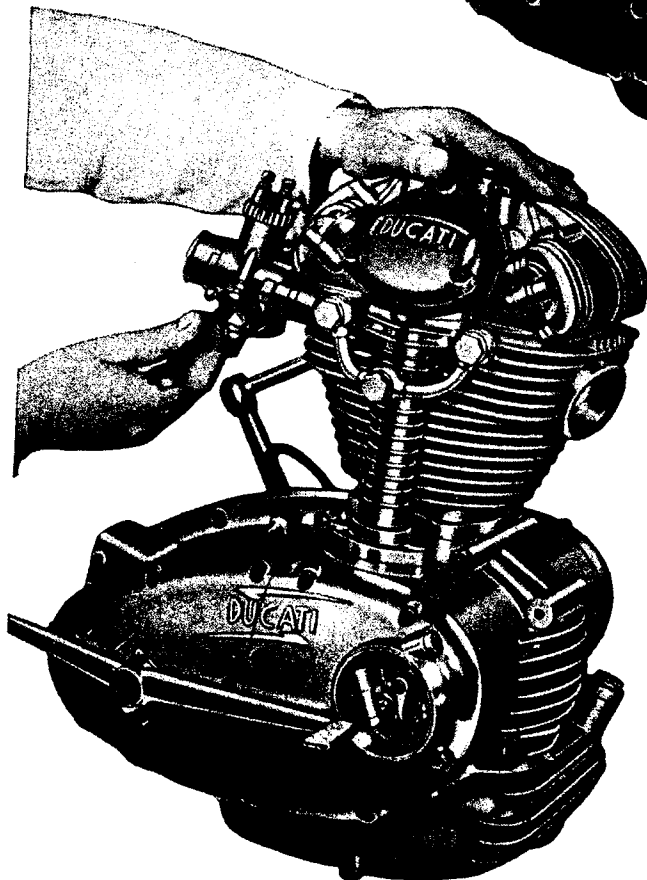
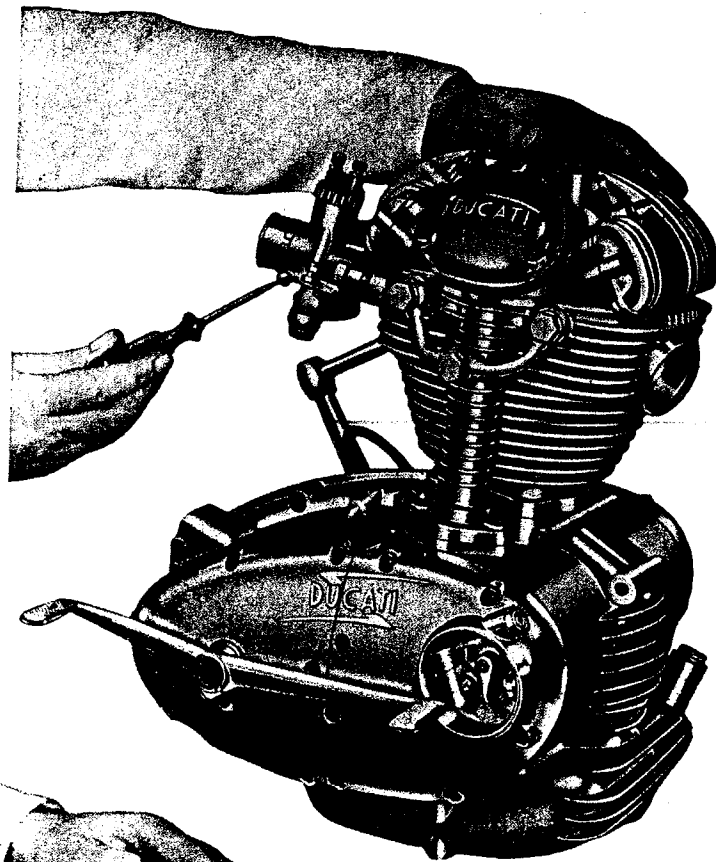

**Adjustment
of the throttle**

**MACH 1
MARK III
SCRAMBLER**

**Adjustment of
minimum air
intake**

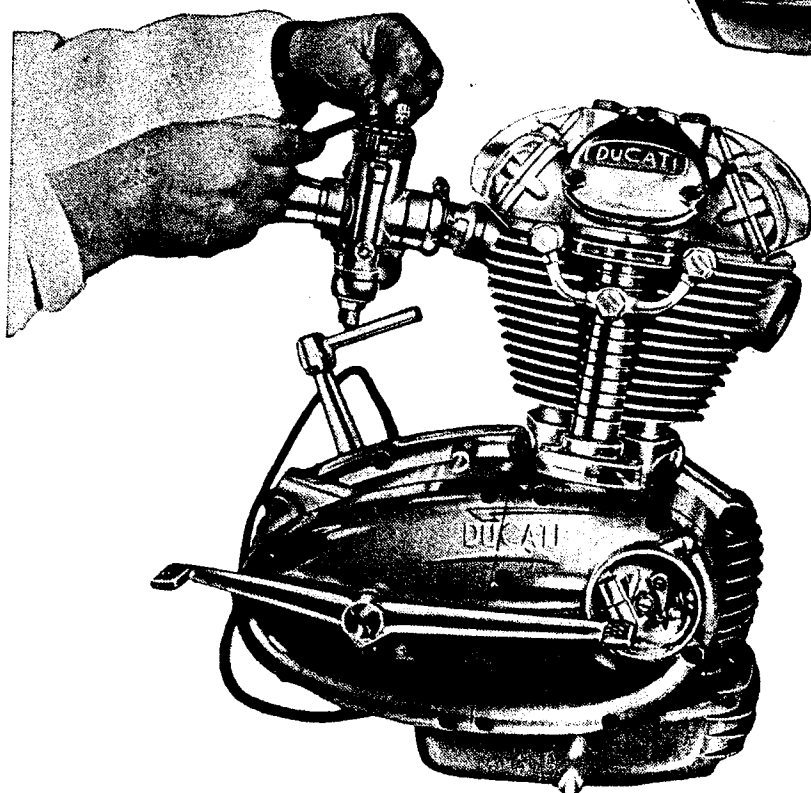
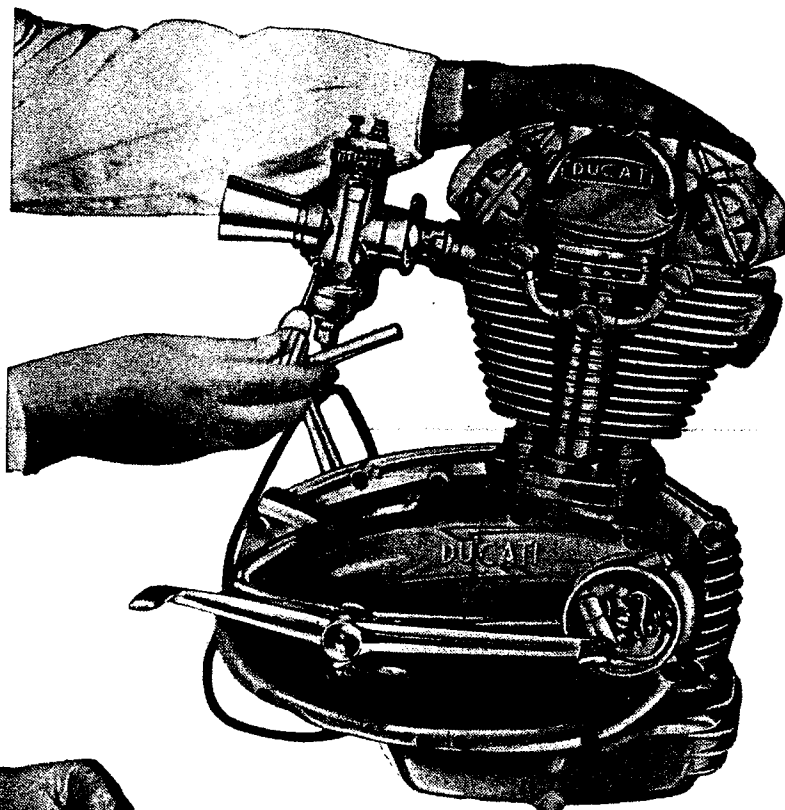

**Adjustment of
the throttle**

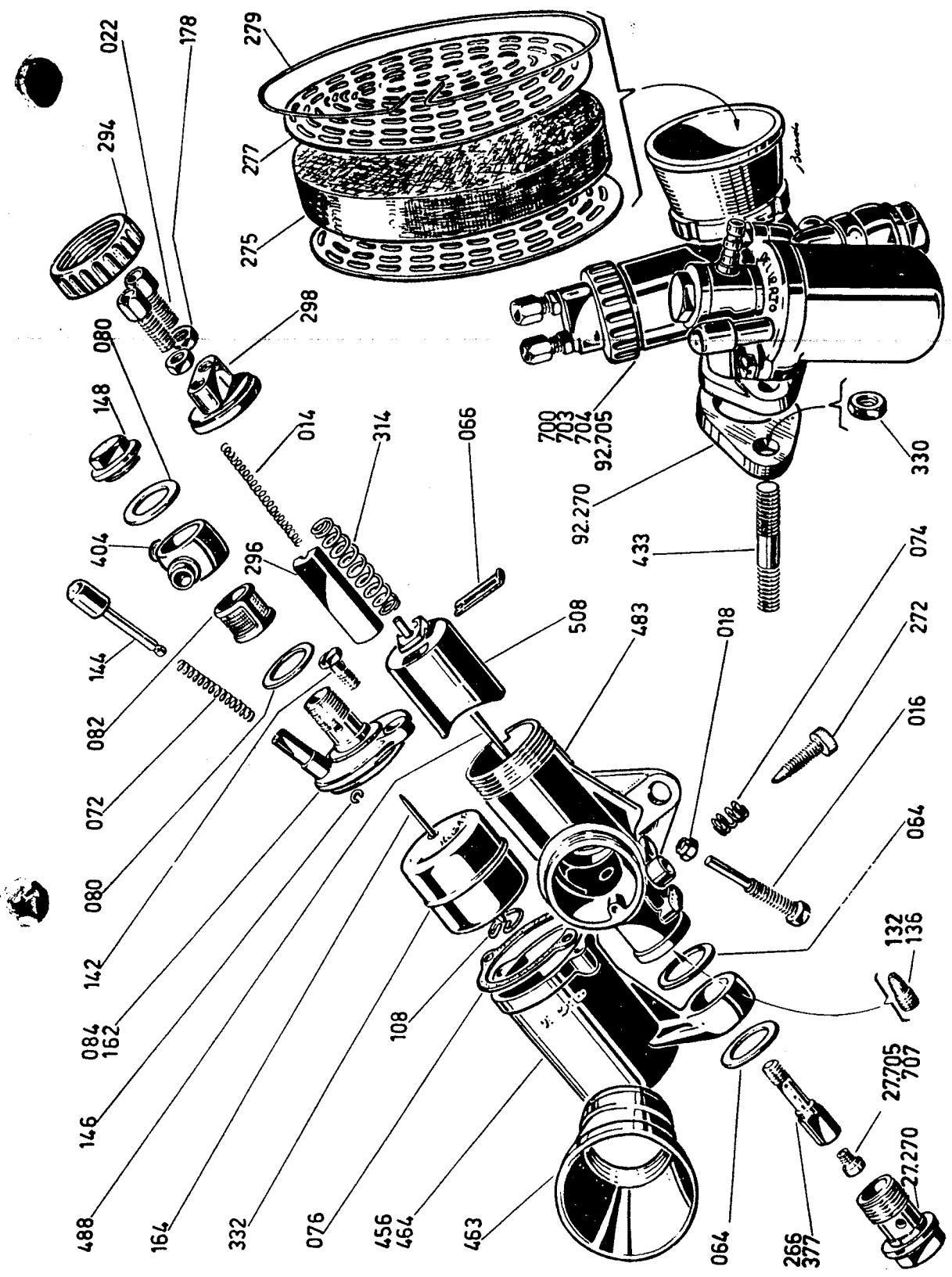

Instance: Carburetor Dell'Orto UBF 24 BS - Spare parts in the 250 GT and MONZA

PETROL FEED

The petrol is fed to the carburetor by gravity. The carburetor is Dell'Orto with quiet air intake on the tool-box, for the 250 GT and Monza, with normal intake in the other models.

Models	Carburetor	Atomizer	Choke	Main jet	Idling jet
GT	UBF 24 BS	260 B	24	108	40
MONZA	UBF 24 BS	260 B	24	108	40
MACH 1	SSI 29 D	265	29	118	50
MARK III	SSI 29 D	265	29	125	50
SCRAMBLER	SSI 27 A	265	27	112	50

The petrol tank (for capacities and numbers of taps see the list) is provided with a three position tap: closed - open - reserve.

Models	Petrol tank capacity lt.	Taps number	Reserve lt.
GT	17 (imp. gal. 3.7396 = USA gal. 4,4909)	2	1.6 (imp. gal. 0.35196 = USA 0.4227)
MONZA	13 (imp. gal. 2.8597 = USA gal. 3,4342)	2	1.6 (imp. gal. 0.35196 = USA 0.4227)
MACH 1	16 (imp. gal. 3.5196 = USA gal. 4,227)	2	1.6 (imp. gal. 0.35196 = USA 0.4227)
MARK III	16 (imp. gal. 3.5196 = USA gal. 4,227)	2	1.6 (imp. gal. 0.35196 = USA 0.4227)
SCRAMBLER	11 (imp. gal. 2.4197 = USA gal. 2,9059)	2	1.6 (imp. gal. 0.35196 = USA 0.4227)

LUBRICATION

The engine is pressure lubricated, by means of a gear pump driven by the shaft; this pump takes the oil through a filter, from the lowest point of the crank-case which acts as an oil sump, and forces it through proper oil-ways, to all parts of the engine which have to be lubricated. The oil returns by gravity.

The sump capacity is of about 2 Kg. (4,409 lb) = lt. 2.400 (0.634 gall. USA = 0.5279 imp. gall.).

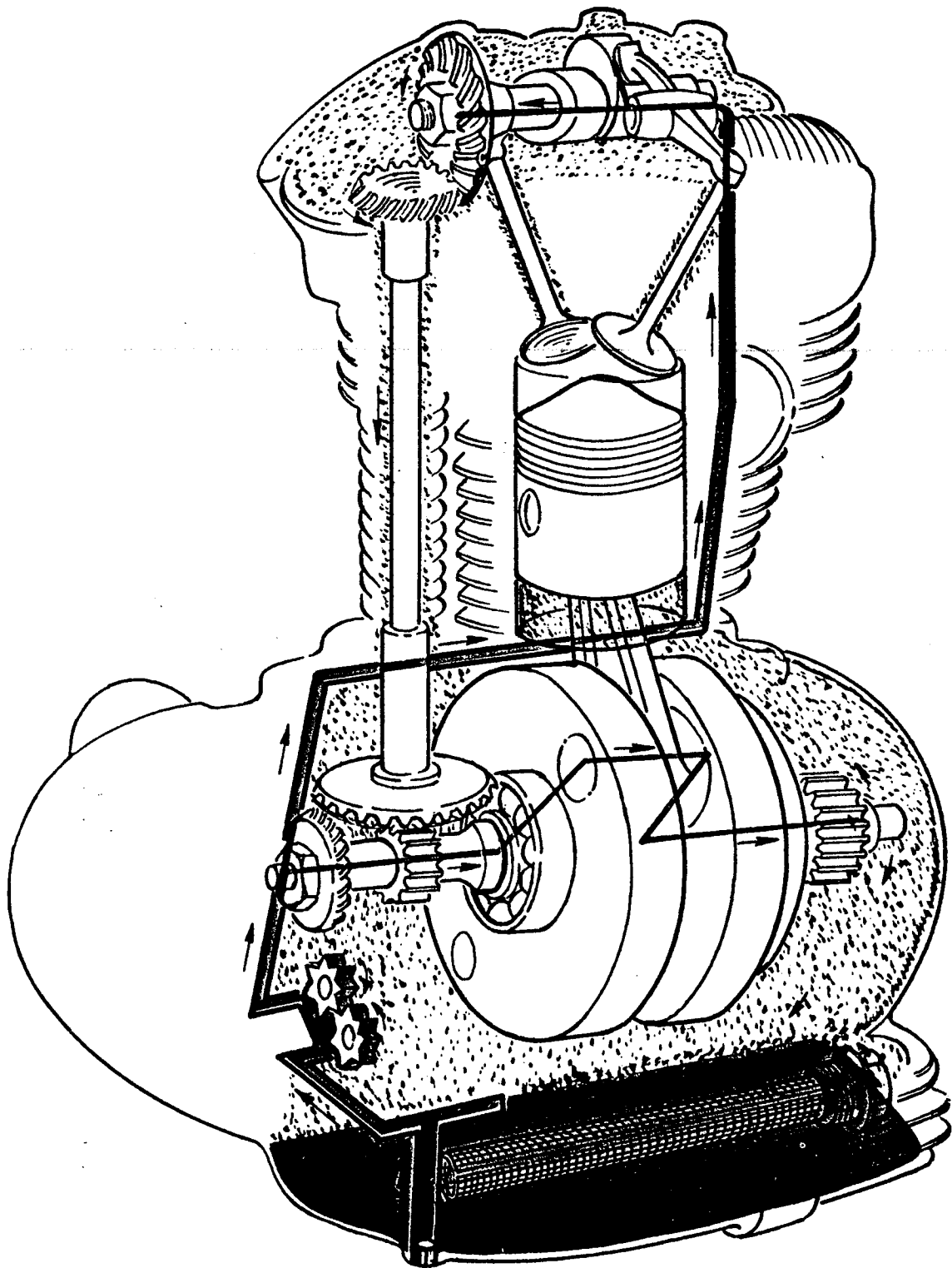

An Oil-filler with stick consisting of:

- 1) Stick-provided filler plug;
- 2) Sealing gasket;
- 3) Filler;
- 4) Sealing gasket;

allows the oil level measurement.

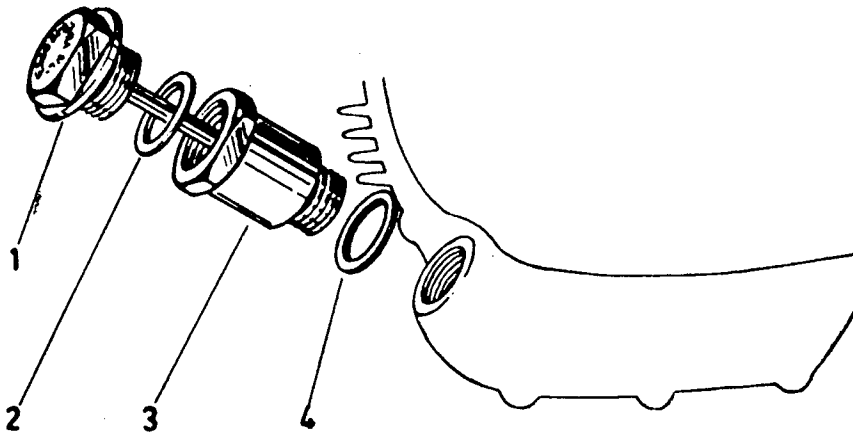

The filler plug stick is marked by two notches in the spots where the oil level is respectively at its lowest and at its highest point.

The oil level is measured by just resting the plug on the filler.

- The lubricating system of the DUCATI motorcycles with single over head cam-shaft engine is of the simplest and requires no special maintenance except the renewal of the oil level ( ESSO EXTRA MOTOR OIL 20 W - 30-40 or RACER 40) each 500 Km. (about 310 miles) and the total change of the oil, including the cleaning of the filter every about 2000 Km. (about 1240 miles).

CENTRIFUGAL OIL FILTER INSERTED IN THE MAIN-SHAFT

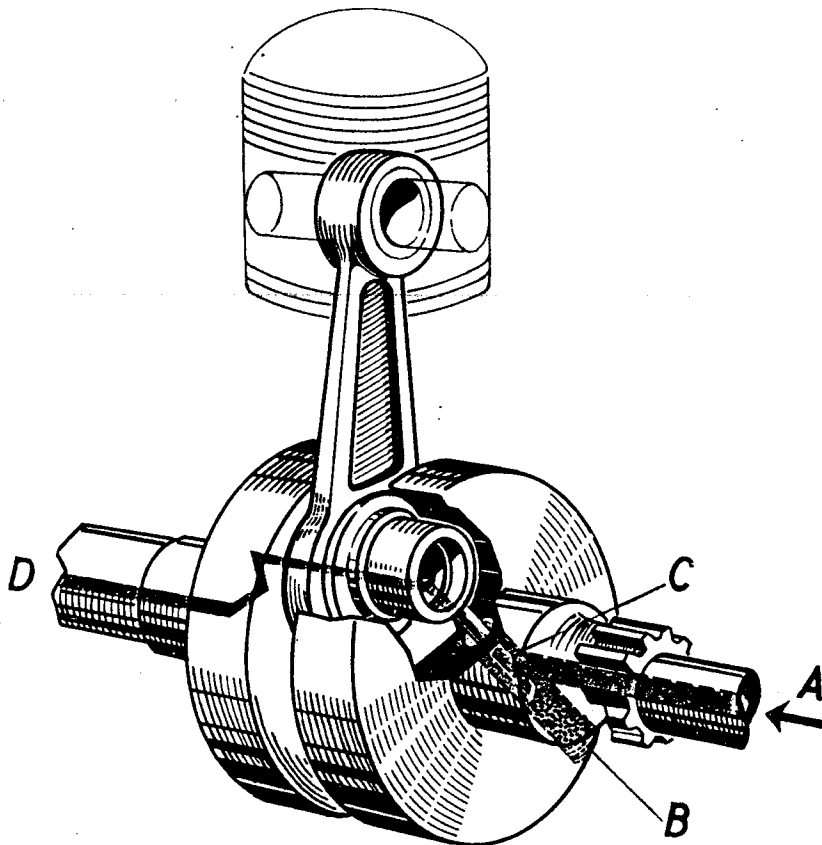

How it works

The oil which is to be filtered, is brought to the filter through the pipe A; from here, the centrifugal force eliminates all the impurities (which are heavier than the oil), which accumulate all around the threaded plug B of the main shaft.

The filtered oil, goes through the tube C to lubricate the big end, and through the duct D, to lubricate the engine-clutch housing gear.

COOLING

Cooling of the engine is achieved by close finning of both the cylinder and cylinder head.

IGNITION

The ignition is battery-coil.

The partial automatic advance ignition is:

Model	Advance with stopped engine	Amplitude of automatic advance	Total advance with engine running at 3.000 r.p.m.
GT	5° to 8°	28°	33° to 36°
MONZA	5° to 8°	20°	33° to 36°
MACH 1	5° to 8°	20°	33° to 36°
MARK III	21° to 23°	18°	33° to 41°
SCRAMBLER	21° to 23°	18°	39° to 41°

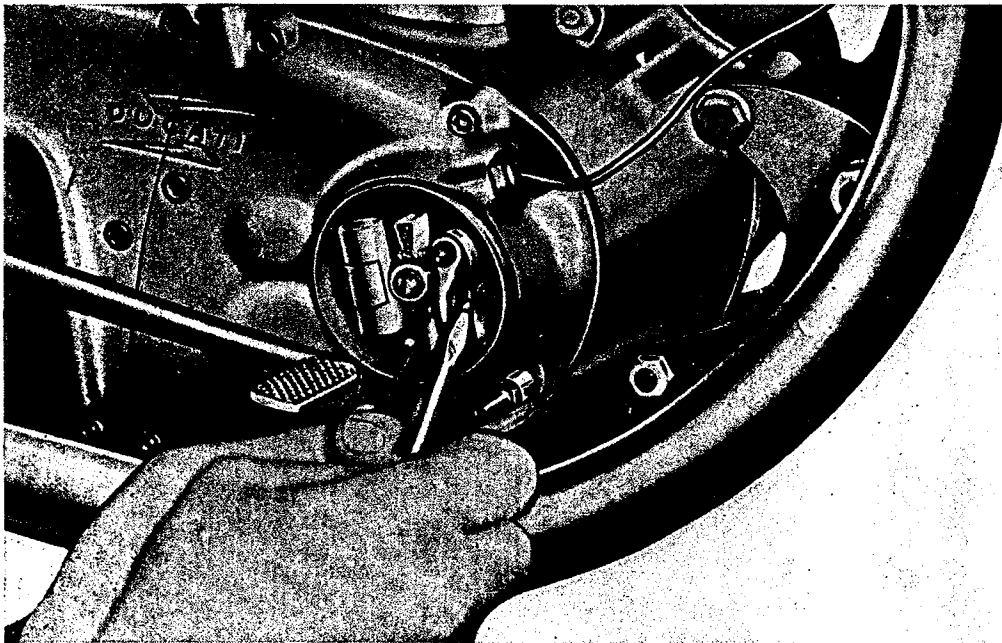

For setting up the ignition, see figure on page 20.

The clearance between the platinum plated contacts is of 0.3 to 0.4 mm. (0.0118" to 0.0157") and has to be checked by means of the feeler gauge (see figure hereupon).

The ignition plug is a Marelli CW 260 N, or a similar model and is located on the leftside of the top of the cylinder head.

When replacing the sparking plug make sure the angle of the plug, relative to the plughole, is correct otherwise there is a risk of stripping the thread in the cylinder head. Screw the plug lightly at first, then tighten it.

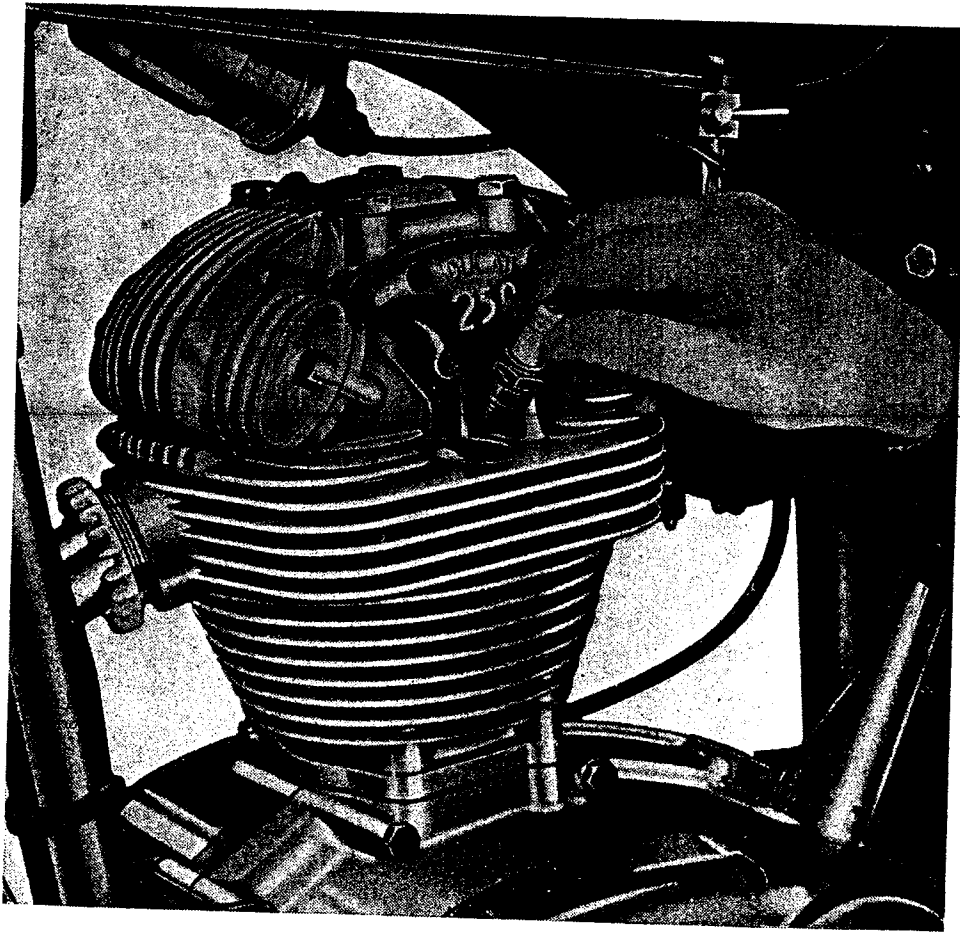

HOW TO CHECK IGNITION SPARK ADVANCE

Check periodically the ignition spark advance (after the first 600 and, after, every 1200 miles); be sure that the automatic device works properly, that it is well lubricated and that the springs are neither *out of shape* nor *out of place*.

the rotary amplitude of the automatic advance must be 14° equal to 28° on the driving shaft in the models GT, Monza, Mach 1, and must be 9° equal to 18° on the driving shaft in the models Mark III and SCRAMBLER. If you have any doubt, get it checked by a specialized workshop. To check the spark advance, proceed as follows:

- 1st. - Remove the threaded plug which is at the driving shaft level, and fit a suitable timing chart (Fig. 1).
- 2nd. - Fit an indicator on one of the screw that secure the cover (Fig. 1).

- 3rd. - Bring engine to TDC of compression stage and set the indicator at « 0 » of the timing chart.
- 4th. - Rotate the driving shaft clockwise for about a quarter of a turn.

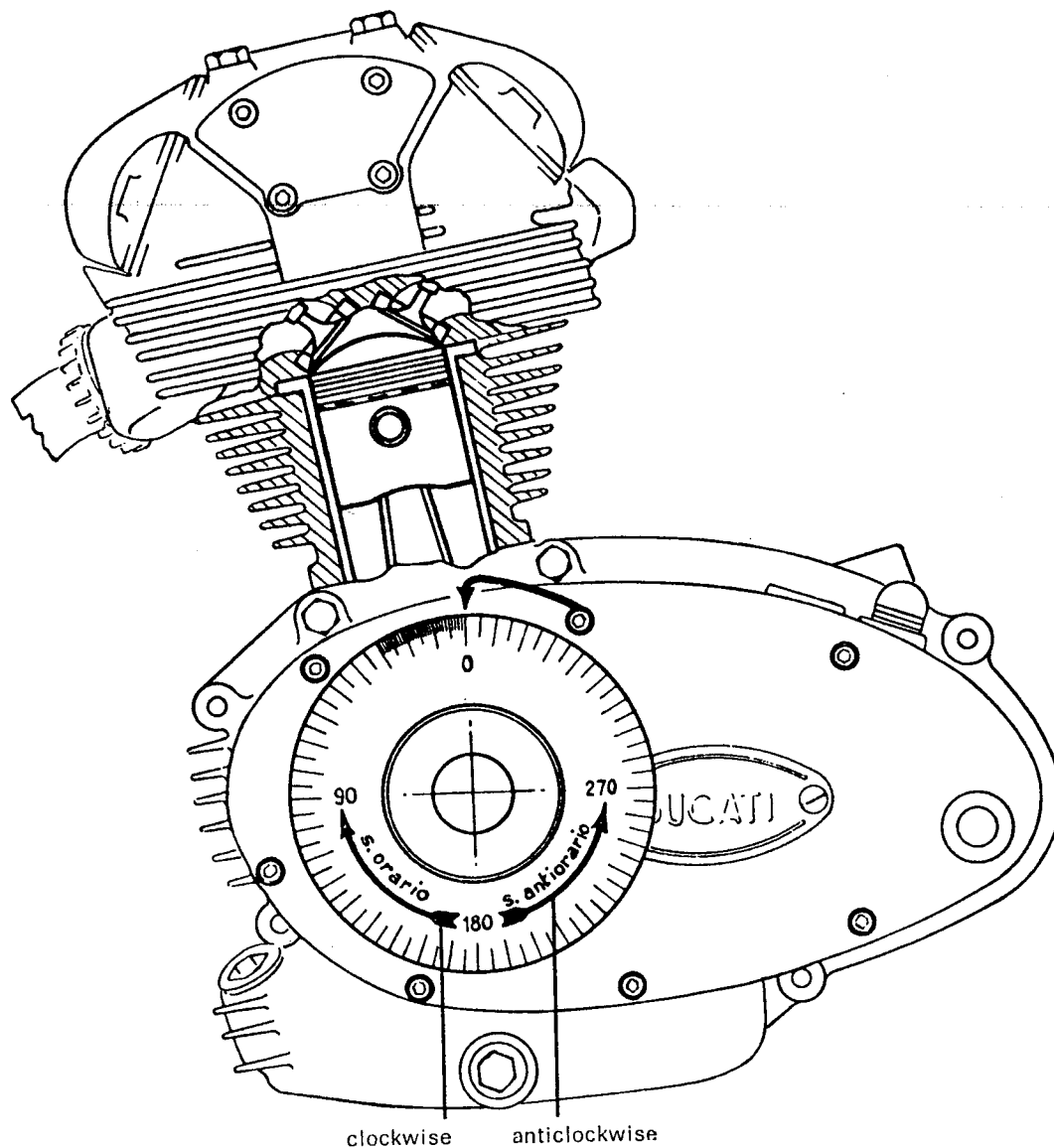

(Fig. 1)

- 5th. - To the spring of the mobile part of the contact breaker connect a 6V. - 3W. lamp in series with the + of the battery (Fig. 2). The lamp should light up.

6th. - Rotate the driving shaft slowly, anticlockwise, till the light goes out or its intensity is lowered.
At that very moment, the indicator should give on the goniometer the advance degrees you will find on page 28.

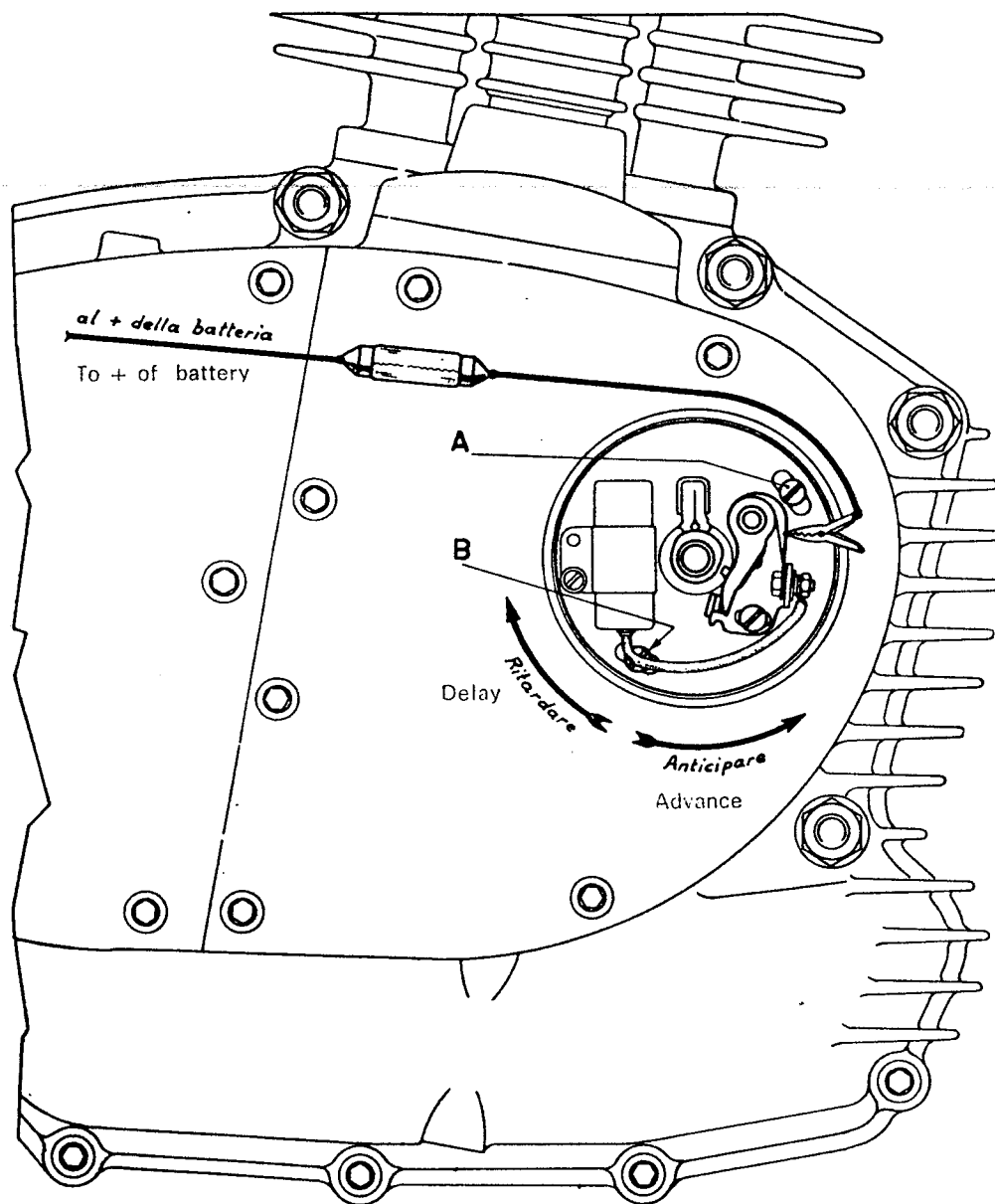

(Fig. 2)

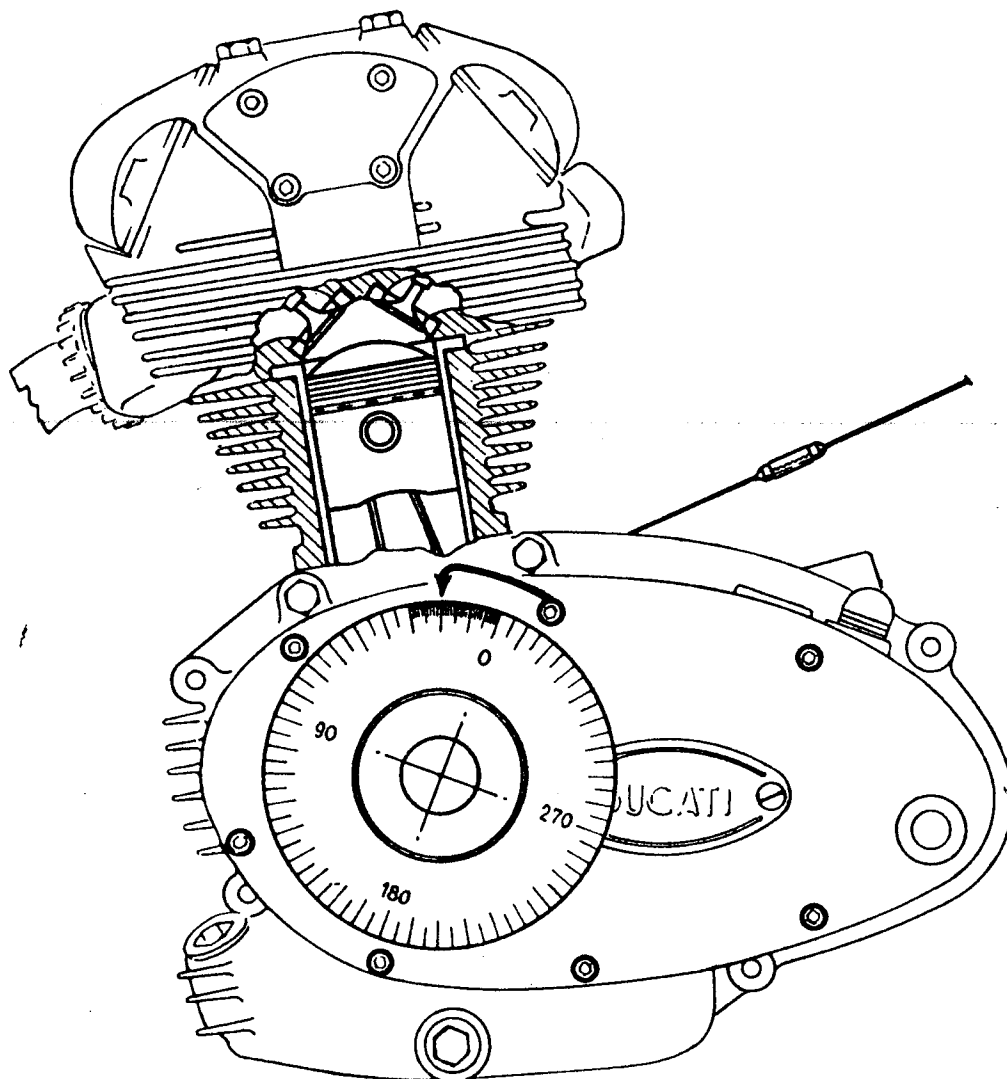

(Fig. 3)

- 7th. - To be on the safe side, it is advisable to repeat the test.
- 8th. - If the reading should not tally with the requested numbers, then loosen the two screws (A and B) which secure the plate, and rotate it, advancing or delaying ignition until the right number found at page 28 is obtained.
- 9th. - Bear in mind that if you let go dry the felt which lubricates the cam, the fibrous slipping block (that operates the opening of the moving part of the contact breaker arm), will tend to wear out, lowering thus, the value of the gap.

STARTING

The kick-starter is located on the left hand side of the engine. In the case the starter unit is refit, it is indispensable to carry it out as shown in the figure aside.

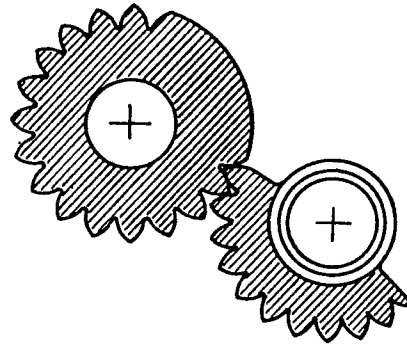

TRANSMISSION

The transmission components comprise a clutch and a gear box. The clutch is of the multiple plate type with

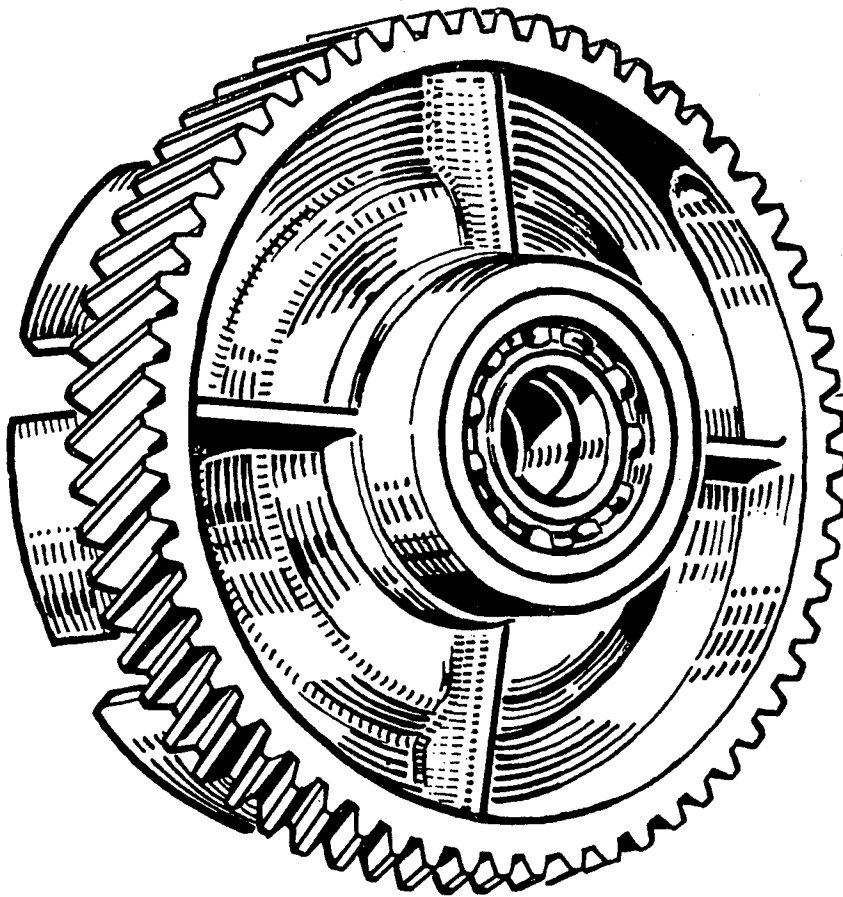

steel and phenol resin disks. It turns in an oil bath and is mounted on the primary shaft on the gear box.

The clutch housing, made of special wear resisting cast iron turns on two inner bearings which are set at an adequate distance. It is lubricated together with the engine sprocket as already explained in the paragraph of the centrifugal filter.

This system ensures smooth movement, solidity and long wearing; it has been fitted and tested on the 200 cc. motorcycles, since 1960.

The clutch is operated by a handlever placed on the left hand side of the handlebar.

The transmission between the engine and the primary shaft of the gearbox is obtained by means of gears and the reduction ratio is:

2.500 to 1.

The gearbox is mounted in the crankcase; the gears for the 5 speed gearbox are constantly meshed and are operated by a foot pedal.

The transmission ratios of the gears are the following:

- in bottom gear 1 to 2.53
- in second gear 1 to 1.73
- in third gear 1 to 1.35
- in fourth gear 1 to 1.10
- in top gear 1 to 0.97

The transmission between the gearbox and the rear wheel is made by means of a chain and the speed ratio is:

- 2.647 to 1 for the 250 GT and Monza.
- 2.222 to 1 for the 250 MACH 1 and Mark III,
- 3.929 to 1 for the 250 SCRAMBLER

FRAME

The frame of the DUCATI motorcycles is of a very smart and modern design, is manufactured with high tensile steel and is of the central girder type.

SUSPENSION

The front suspension is composed by the DUCATI telescopic-hydraulic long-stroke fork, with steering rod. Each fork leg contains $100 \div 110$ cu. cm. (cu. inch 6.1025 to 6.7127) of HYDRAULIC FLUID 5420 oil.

The rear suspension consists of a robust hinged fork with double action hydraulic dampers, (shock-absorbers), which can be adjusted for three different loads: Minimum - Medium - Maximum.

On these machines the fork fulcrum-spindle is fixed to the frame while the fork with bronze bush rotates on it. This gives the machines greater solidity and stability.

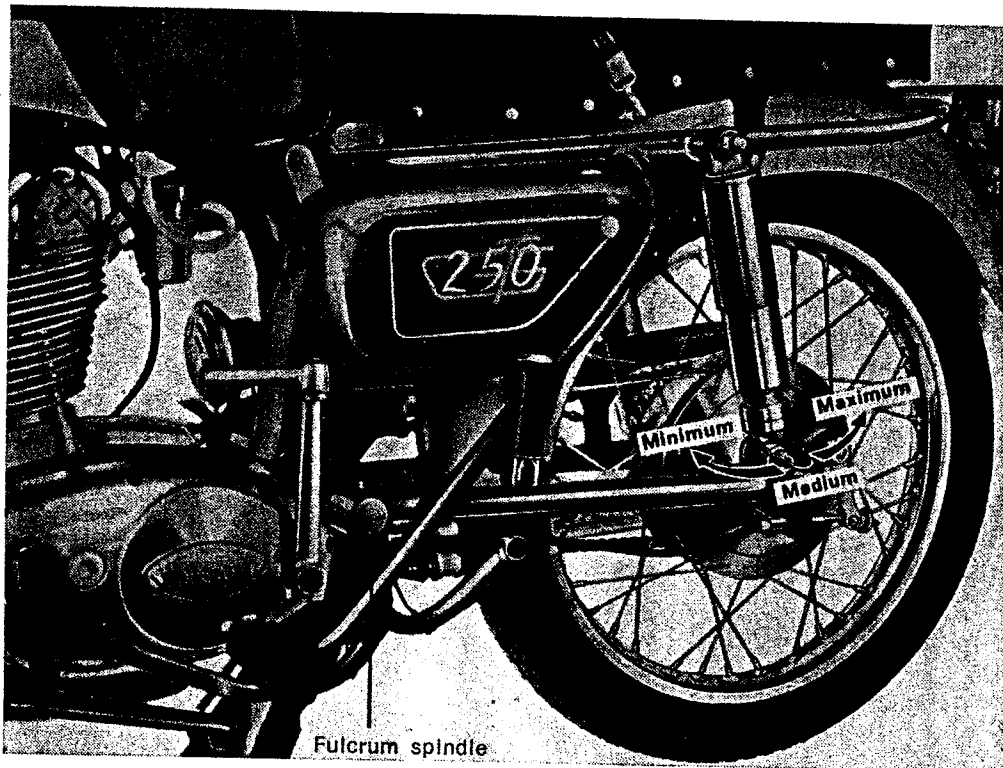

WHEELS

The wheels are of the spoke type with rims as follows :

Model 250	Wheel Rim		Wheel rim size	
	Material	Profile	Front	Rear
GT	Steel	Normal	18 x 2½	18 x 2½
MONZA	Steel	Normal	18 x 2½	18 x 2½
MACH 1	Steel	Normal	18 x 2¼	18 x 2¼
MARK III	Steel	Normal	18 x 2¼	18 x 2¼
SCRAMBLER	Steel	Normal	19 x 2½	19 x 2½

The front wheel has a detachable spindle.
 The rear wheel has a special cushion drive.
 Tyres and pressures are as follows:

Model 250	Front wheel		Rear wheel	
	Tyre	Pressure	Tyre	Pressure
GT and MONZA	2.75-18 ribbed	2,25 Kg/cm ² (32,01 lb/sq. inc.)	3.00-18 grooved	2,25 Kg/cm ² (32,01 lb/sq. inc.)
MARK III and MACH 1	2.50-18 ribbed	2,25 Kg/cm ² (32,01 lb/sq. inc.)	2.75-18 grooved	2,25 Kg/cm ² (32,01 lb/sq. inc.)
SCRAMBLER	3.00-19 grooved for Motocross	2,25 Kg/cm ² (32,01 lb/sq. inc.)	3.50-19 grooved for Motocross	2,25 Kg/cm ² (32,01 lb/sq. inc.)

BRAKES

The brakes are of the expanding type with two brake-shoes, — hand operated the front and pedal operated the rear — with finned brake drums of large diameter width, and with non fade brake linings.

The diameter of the front brake drum is 180 mm (7.0866"), the diameter of the rear drum is 160 mm (6.2992").

NEW ELECTRICAL SYSTEM (250 GT - MONZA - MACH 1)

The lighting is provided by a storage battery which is recharged by the DUCATI flywheel alternator and rectifier. The head-lamp APRILIA of large diameter carries 3 lights. A mile speedometer VEGLIA with dial of 100 for the 250 GT and Monza, and of 150 for the 250 MACH 1, is incorporated in the same headlamp.

The 3-way switch for the light control is situated on the head lamp. A removable key, placed on the headlamp provides the contact for the ignition. By removing the key the engine is stopped.

Alongside the lefthand grip of the handlebar is the switch for the diplight, the antidazzle light, and the button for the horn.

In the normal position on the rear mudguard are placed the number-plate carrier, the rear light, the reflector, the numberplate lighting and the Stop-light.

When the engine is stopped, the electrical current for the position lights (town light and rear light) is provided by an acid cell storage battery SAFA, mod. 3L3, of 6 V - 13.5 Ah; the charge is maintained by means of the flywheel alternator and rectifier.

To avoid ruining the efficiency of the rectifier, never run the engine without battery. (In case the battery is discharged, see remedy on page 50.

ADVANTAGES OF THE NEW ELECTRICAL EQUIPMENT (250 GT - MONZA - MACH 1)

The electrical system with static regulator of current offers real advantages in comparison with the system employed till now.

The advantages can be summarised as follows:

- 1) Regulation of the automatic charge.
- 2) There are no electrical contacts with the regulator and therefore there is a greater surety in the working.
- 3) Simplified commutator system which is limited to the sole lights section.
- 4) Possibility of controlling the charge through the red pilot light.
- 5) Protection of the electrical system on 3 fuses and then, possibility to briefly locate the eventual breakdown and allow the remaining part of the equipment to be operative: the fuse (7) protects the equipment of the front and rear parking lights; the fuse (13) protects the equipment of the head light (dazzling and anti-dazzling); the fuse (14), the horn and the stop indicator (see the electrical scheme).
- 6) Greater simplicity of operation and wiring.

WIRING SYSTEM OPERATION (250 GT - MONZA - MACH 1)

1) Key inserted:

the red ignition light lights up when the engine is started and revs at tick over. The light should go out and stay out all the time the engine is running faster than tickover.

commutator:

position 0 - light switched out

position 1 - switched on the rear and front parking lights as well as the green warning light.

position 2 - switched on projector light commutable in dazzling and anti-dazzling lights.

the battery charge is well-balanced in all conditions.

the horn is operating
the stop indicator is operating

2) Key not-inserted:

the machine cannot be run
the red warning light does not lit

commutator:

position 0 - lights switched out

position 1 - switched on the rear and front parking lights as well as the green warning light.

position 2 - projector light does not lit.

the battery cannot be charged.

The connection between the static regulator of current and rectifier-battery is cut-out.

The horn does not operate.

The stop light indicator does no operate.

ELECTRICAL SCHEME (250 GT - MONZA - MACH 1)

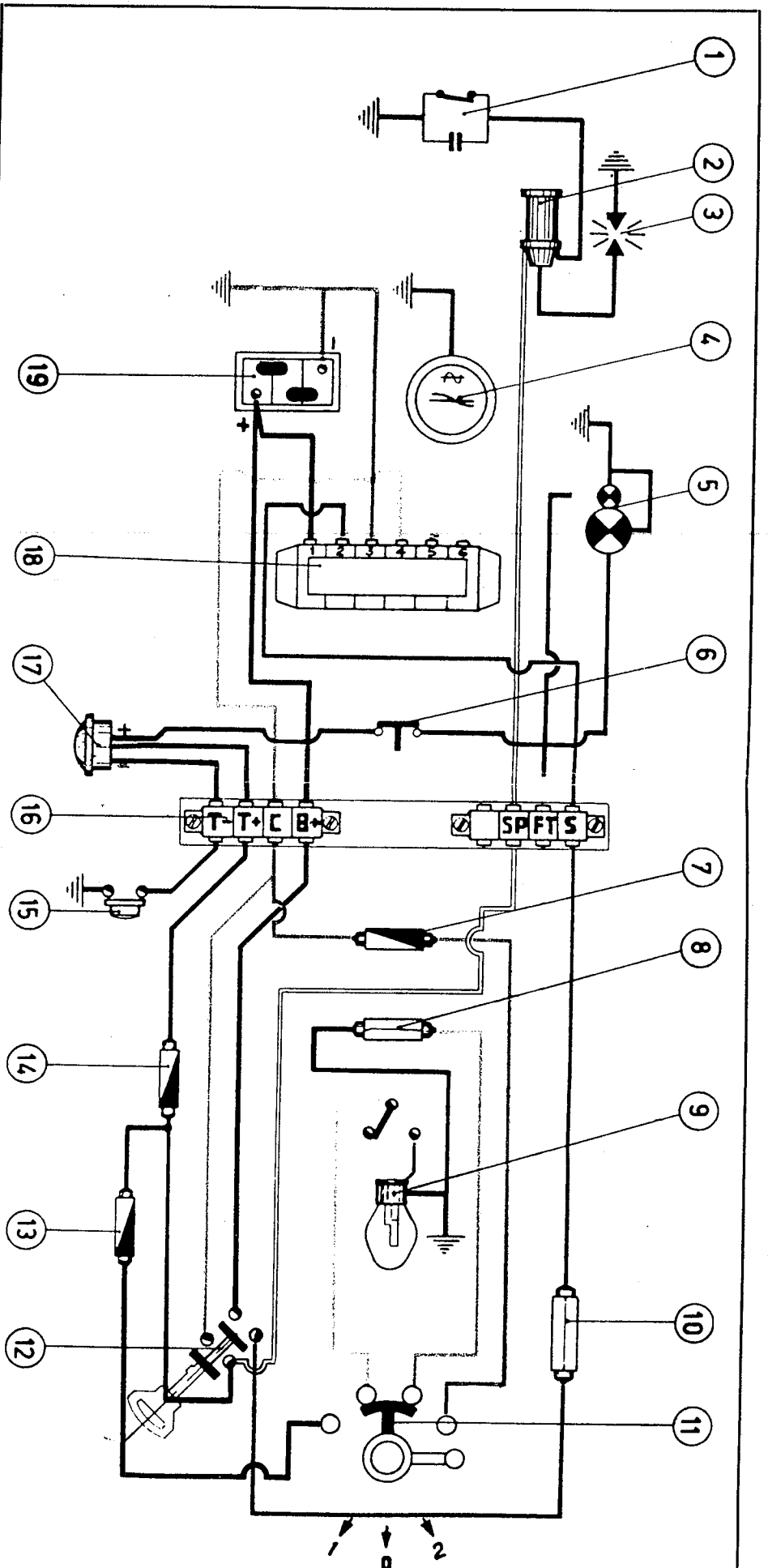

KEY TO PARTS OF THE ELECTRICAL SCHEME

- 1 - Contact breaker-condenser
- 2 - Ignition coil in cc. 6 V
- 3 - Sparking plug
- 4 - Generator 6V-60W
- 5 - Plate carrier and Stop Light 6V-3/15W
- 6 - Stop light switch
- 7 - Fuse protecting the system of the front and the rear parking lights
- 8 - Bulb for front parking light 6V-3W - warning green light
- 9 - Bulb of the headlamp 6V-25/25W
- 10 - Bulb for the charge warning red light 6V-1.5W
- 11 - Three position commutator
- 12 - Extractable 4 contact-key
- 13 - Fuse protecting the projector light equipment (dazzling and anti-dazzling)
- 14 - Fuse protecting the horn and the Stop Indicator
- 15 - Horn push button
- 16 - Terminal block for headlamp
- 17 - Horn 6V cc.
- 18 - Static regulator of current and rectifier 6V - 10A
- 19 - Battery SAFA 3L3 - 13.5 Ah - 6V

ELECTRICAL SYSTEM (250 MARK III - Scrambler)

The engine of the DUCATI 250, MARK III and Scrambler is supplied with an alternator-flywheel magnet of the outer H.T. coil type.

The coil supplies the lighting plant with 40 W.

The components of this generator are:

- 1) the rotating flywheel, comprising the magnets with their polar expansion, the drum sustaining the magnets and the hub.
- 2) the stator plate comprising the 3 inductors with their corresponding magnet cores.

NOTE!

When the flywheel is to be fitted on the driving shaft, in these models and the previous ones, be careful it is in perfect phase. To carry it out, proceed as follows: Having the piston at the Top Deal Center (T.D.C.) and the driving shaft key and flywheel mark in the position shown in the figure, let the flywheel rotate anti-clockwise, for the angle α , till it attains the new position. The headlamp carries 2 lights: the dip light (6 V. - 25 W.) and the anti-dazzle (6 V. - 25 W.).

On the handlebar, near the left handgrip, is fitted the 2-way light switch (in-out) with the deviator for the dip and anti-dazzle lights.

On the rear mudguard, is fitted the tail light with the 6 V. - 5/20 W. bulb, the catarefractor and the switch. The latter helps to fastly restore the massbalance of H.T. coil when the stop bulb turns burnt.

Therefore when the bulb turns burnt, it is sufficient to displace the switch lever, to restore the H.T. coil massabalance.

250 GT - MONZA -
MACH/1 : $\alpha = 0^\circ$

250 MARK III -
SCRAMBLER

$\alpha^\circ = 32^\circ \div 36^\circ$

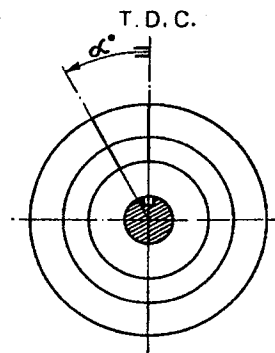

ELECTRICAL SCHEME (250 MARK III and SCRAMBLER)

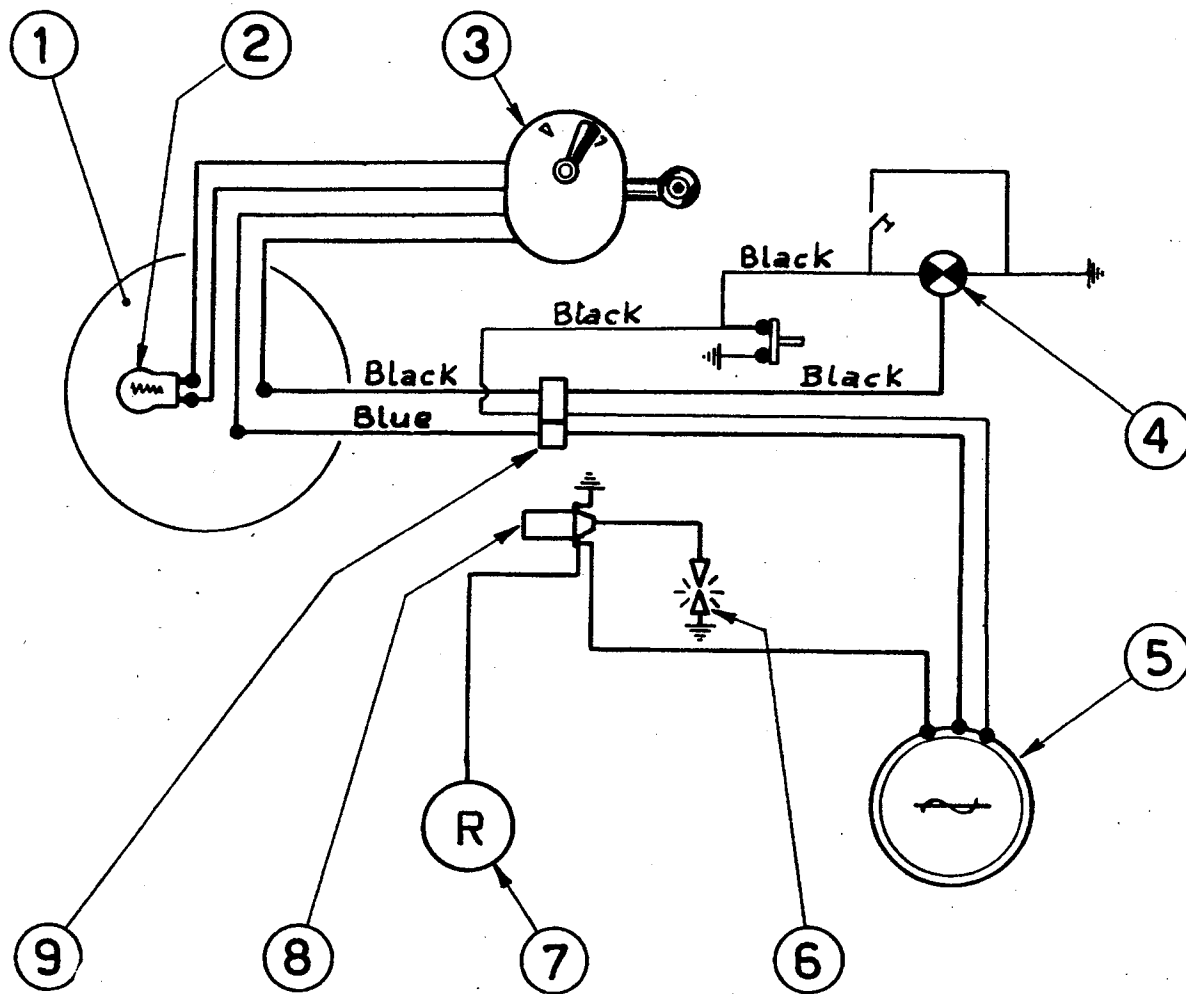

KEY TO PARTS ON THE ELECTRICAL SCHEME

- 1 - Headlamp Aprilia mod. 130 ASN.
- 2 - Filament bulb 6 V-25/25W.
- 3 - Switch and deviator Aprilia 59/N.
- 4 - Tail light 6V-5/20W.
- 5 - Flywheel alternator 6V-40W.
- 6 - Ignition sparking plug.
- 7 - Contact breaker-condenser.
- 8 - Alternated current ignition coil 6V.
- 9 - 3-way terminal block.

CONTROLS

As mentioned in the foregoing paragraph, alongside the left hand fixed handlebar grip will be found the two switches for the dip light and the antidazzle light, the button for the horn (this only in the 250 Monza) the hand operated clutch lever; and above grip is located the little air-regulating lever.

The righthand handlebar grip rotates for accelerating and decelerating the engine. In front of the grip is placed the operating lever for the front brake and the air control lever.

Near the left hand footrest is placed the rear wheel brake lever which also operates the stoplight and the kickstart. Alongside the right hand footrest is the double lever for the gear change.

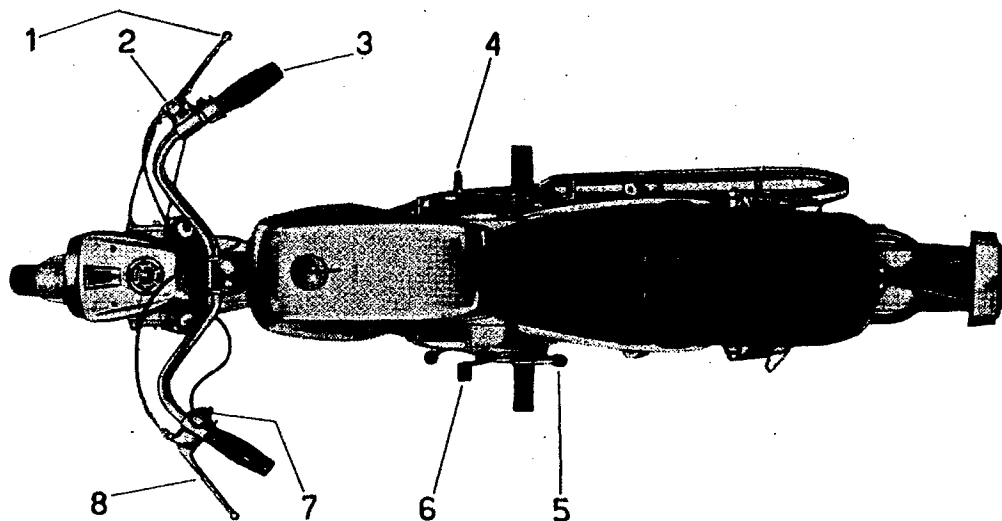

LEGEND

- | | |
|------------------------------------|---|
| 1 - Front brake control lever | 6 - Rear brake control lever |
| 2 - Air regulating control lever | 7 - 2 way switches for dip light and antidazzle light, and button for horn. |
| 3 - Rotating throttle control grip | 8 - Clutch control lever |
| 4 - Change double lever | |
| 5 - Kickstarter | |

SADDLE

The motorcycle are provided with a dual-seat, a hand grip and footrests for pillion rider in the 250 and Monza, and of the racing type in the 250 Mach 1; wide and comfortable saddles in the 250 Mark III and Scrambler.

ADJUSTING OF THE CHAIN TENSION

For the correct chain adjustment up and down movement should be no more than $\frac{1}{2}$ " to $\frac{3}{4}$ ".

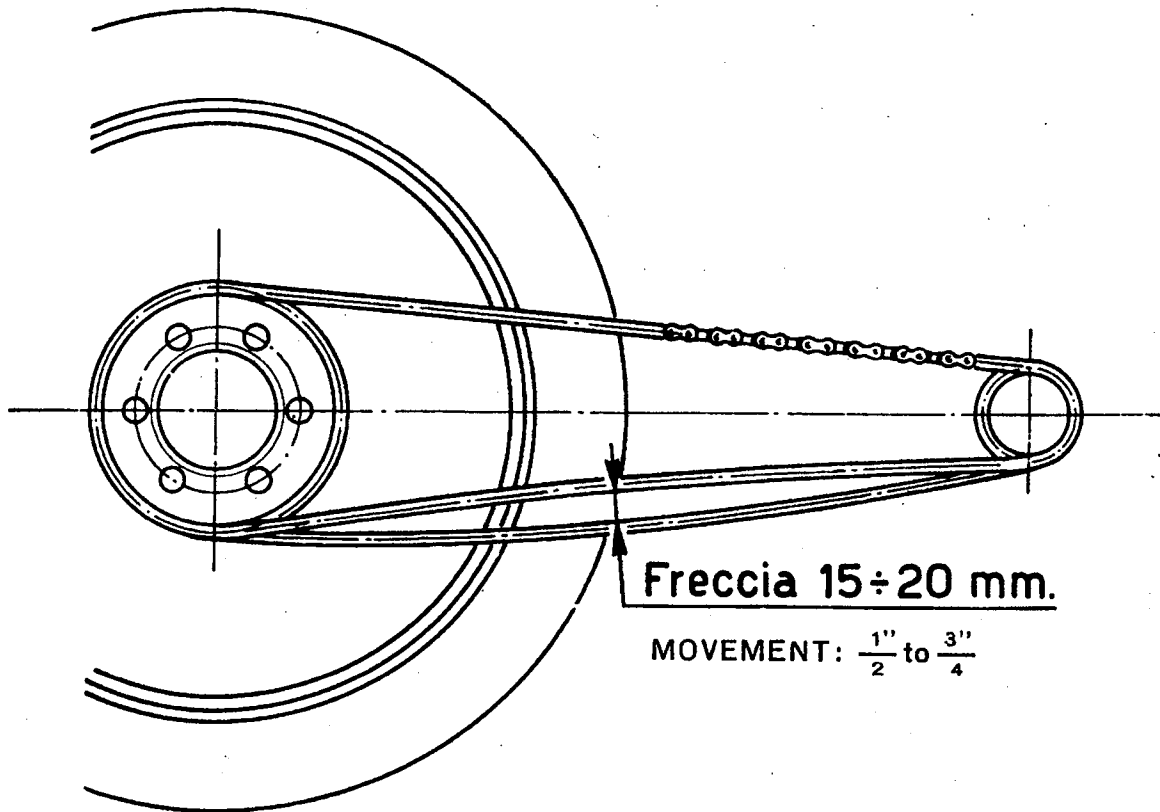

OVERAL DIMENSIONS AND WEIGHT

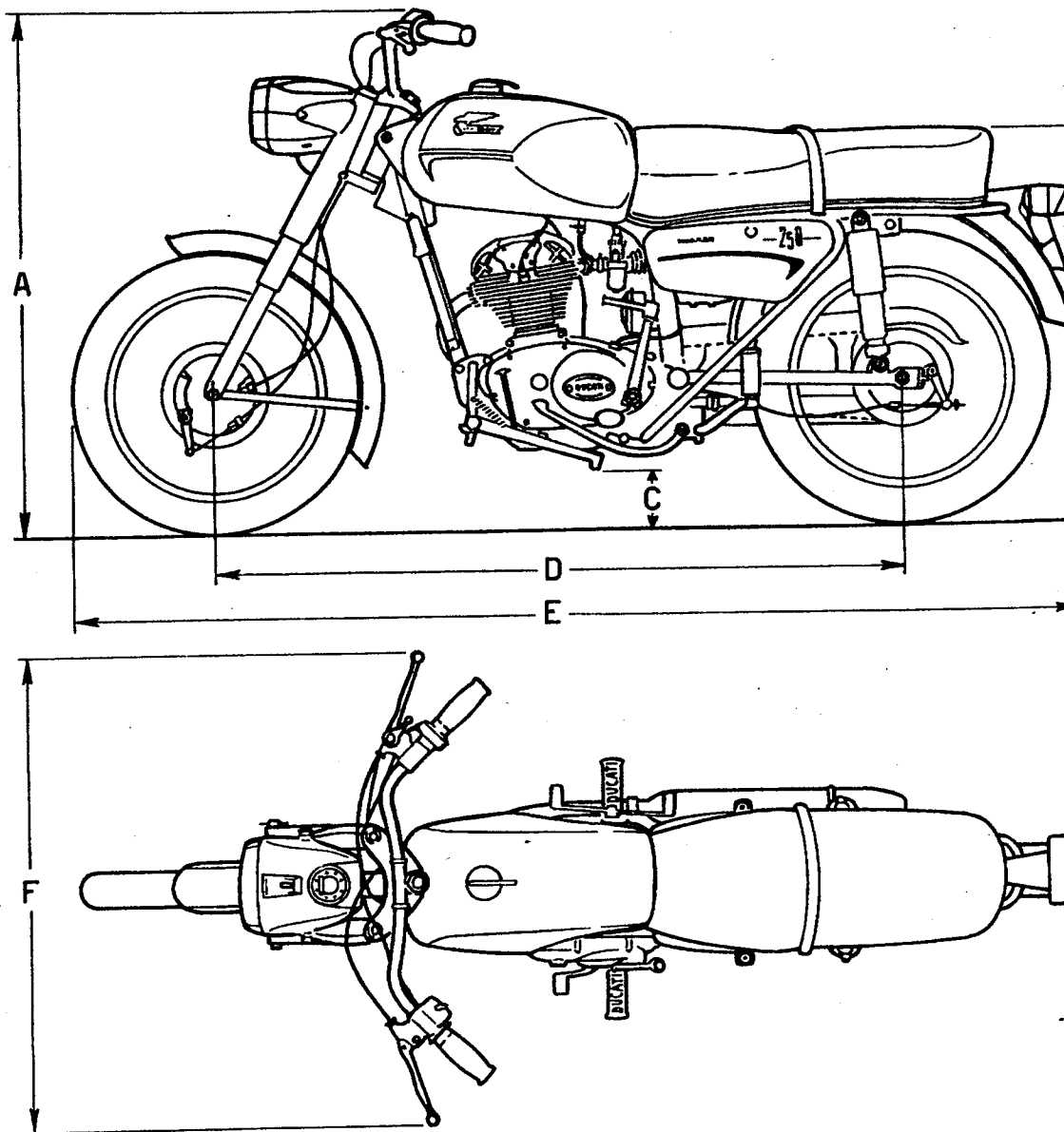

Model 250	A	B	C	D	E	F	Weight
GT	1070 mm. 42.1260"	800 mm. 31.4961"	130 mm. 5.1181"	1320 mm. 51.968"	2000 mm. 78.740"	800 mm. 31.4961"	125 Kg. lb. 275.580
MACH 1	920 mm. 36.2205"	760 mm. 29.9213"	130 mm. 5.1181"	1350 mm. 53.1495"	2000 mm. 78.740"	590 mm. 23.2283"	116 Kg. lb. 255.735
MONZA	1070 mm. 42.1260"	800 mm. 31.4961"	130 mm. 5.1181"	1320 mm. 51.968"	2000 mm. 78.740"	800 mm. 31.4961"	125 Kg. lb. 275.580
Mark III	1070 mm. 42.1260"	800 mm. 31.4961"	130 mm. 5.1181"	1350 mm. 53.1495"	2000 mm. 78.740"	800 mm. 31.4961"	112 Kg. lb. 246.918
SCRAMBLER	1050 mm. 41.3386"	750 mm. 29.5275"	130 mm. 5.1181"	1350 mm. 53.1495"	2020 mm. 79.5276"	820 mm. 32.2835"	120 Kg. lb. 264.555

TOOL BOX

A large tool box of ample capacity is placed under the saddle at the left side of the rider and contains the spanners and the tools supplied with the motorcycle for the normal inspections of the engine, which can be executed by the rider himself (see fig. page 35), only for the 250 GT and Monza models. In the 250 MACH 1 and Mark III the toolbox has 2 compartments and is placed under the saddle.

For the Scrambler model the cloth toolbag is supplied separately.

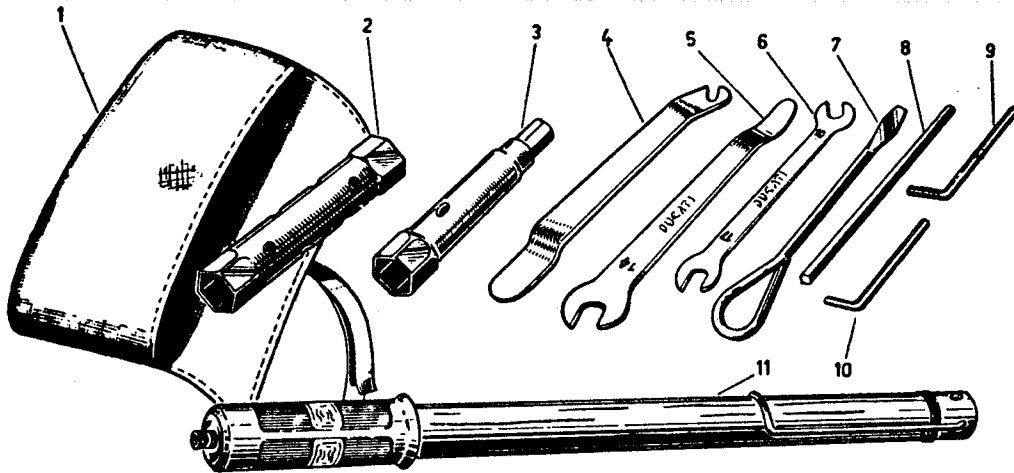

- 1 - Tool bag
- 2 - Double box spanner 19-22 (0.7480 — 0.8661")
- 3 - Double box spanner 21 for hexagon 14 (0.8268 — 0.5512")
- 4 - Tyre lever
- 5 - Hexagon spanner 14 with tyre puller (=0.5512")
- 6 - Double hexagon spanner 10-11 (=0.3937" — 0.4331")
- 7 - Screw driver
- 8 - Tommy-bar for box spanner 21-22 (=0.8268" — 0.8661")
- 9 - Spanner for hollow hexagon 6 (= 0.2362")
- 10 - Spanner for hollow hexagon 5 (= 0.1968")
- 11 - Tyre inflator except for the SCRAMBLER.

On the right side of the 250 GT and Monza, is the air cleaner for the carburetor for the quiet air inlet.

In the inlet duct of the carburetor, is the engine breather which sends oil vapours to the valves for their lubrication.

The battery is located between the two boxes in the said models.

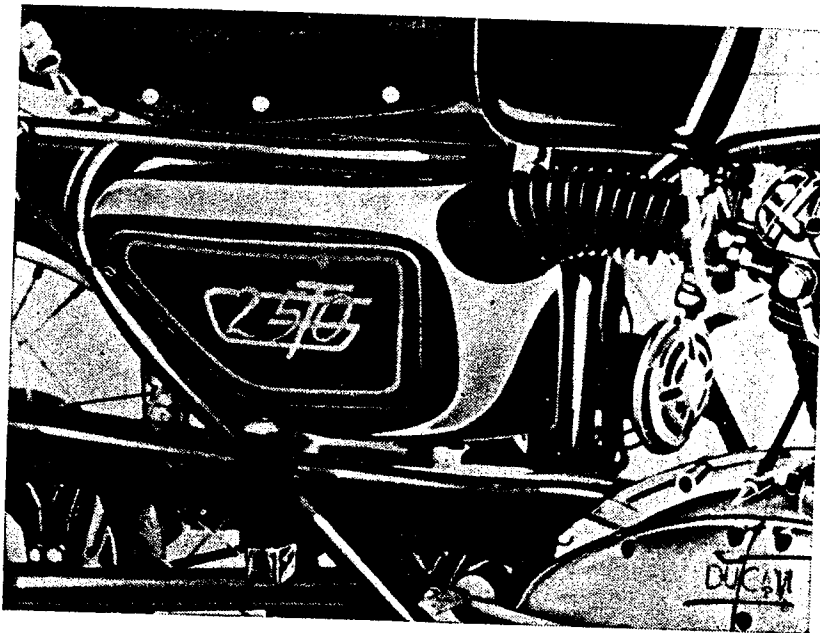

PERFORMANCE

The maximum speeds allowed for each of the gears, correspond to the figures recorded in the red circles of the speedometer reproduced on the next page.

These speeds are obtainable only strictly following the recommendations for the tuning up, mentioned at pages 13 and 1 and periodically carrying out the maintenances described at pages 52 to 58.

250 GT and MONZA

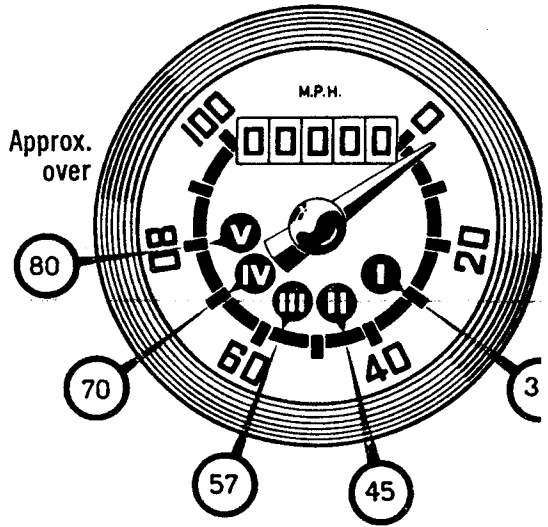
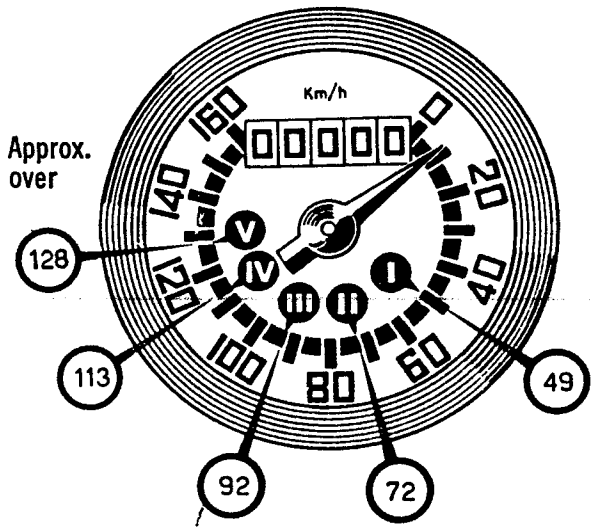

250 MACH 1

(In lowered position race type and with megaphone exhaust).

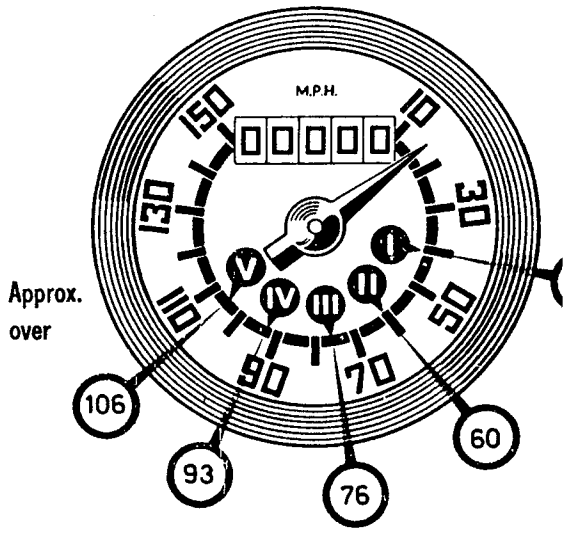
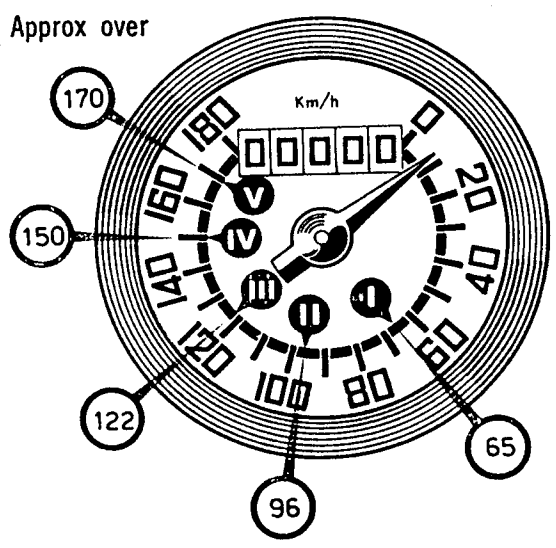

250 MARK III

Approx.
over

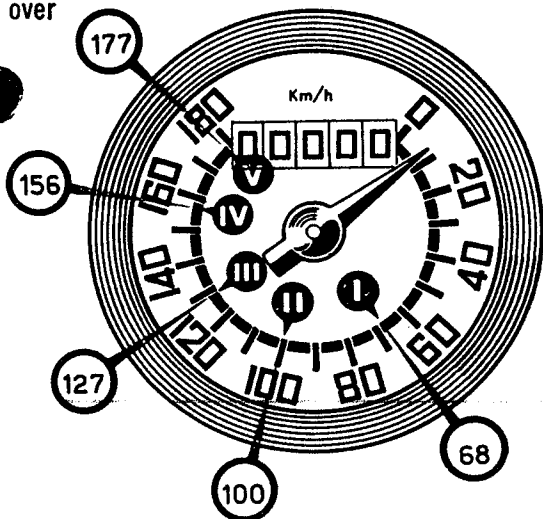

Approx.
over

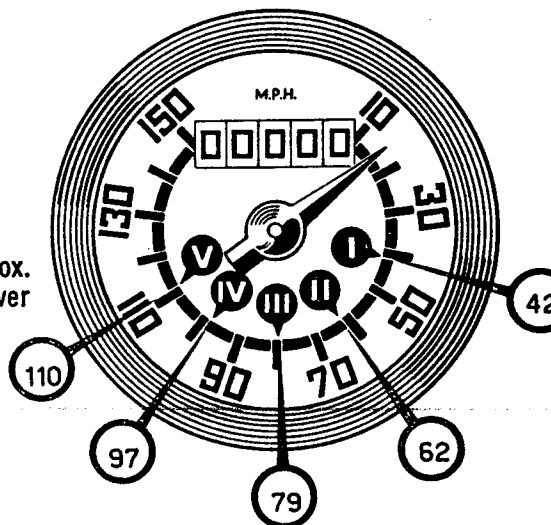

Maximum gradient which can be overcome with rider only, in the various (gears) speeds (except the 250 Scrambler for which the maximum gradient is practically without any limitation).

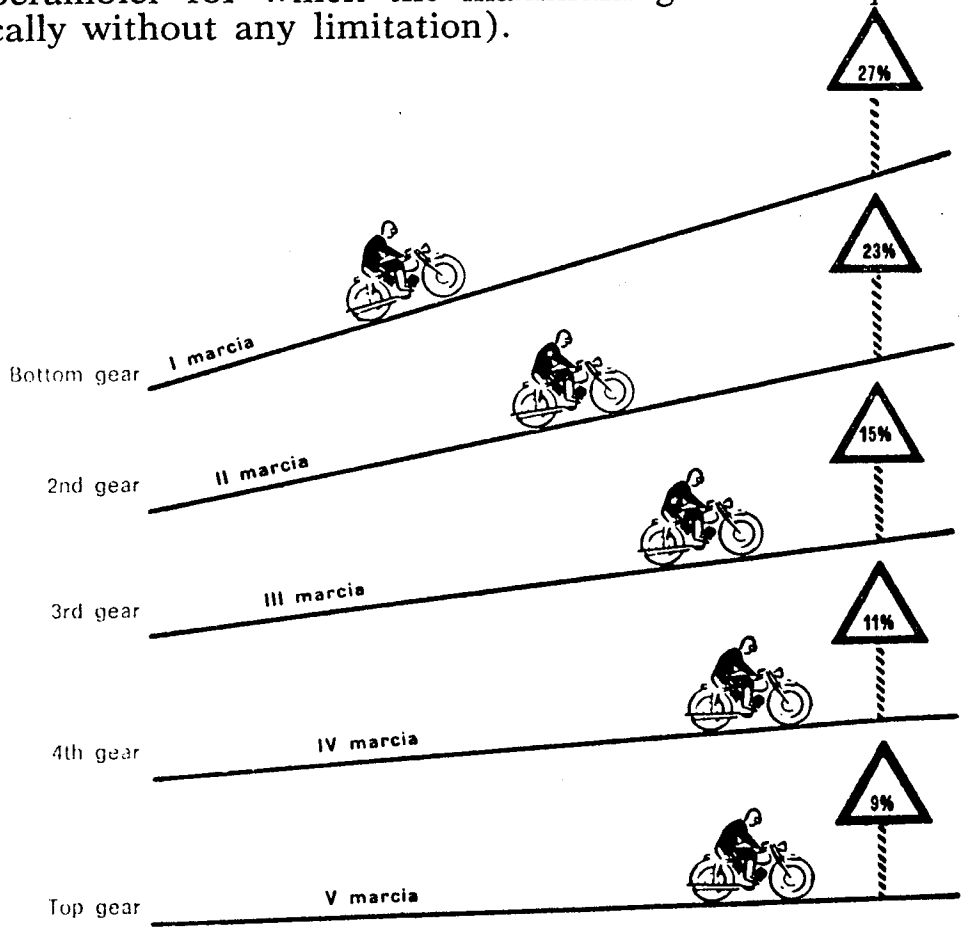

CONSUMPTION AND DISTANCE

250 GT and MONZA

The consumption at an economical speed of $85 \div 90$ Km/h (53 to 56 m.p.h.) about 1 liter = (imp. gal 0,220 \div gall. USA 0.2642) petrol (Esso) ESSO EXTRA per 31 Km. (ml. 19.2624).

Maximum distance of cruising with one tankful, 527 Km. (m. 327,267) for 250 GT and 403 Km. (ml. 250,263) for Monza.

250 MACH 1 and MARK III.

The consumption at an economical speed of $85 \div 90$ Km/h (53 to 56 m.p.h.) about 1 liter (= gall. USA 0.2642 \div imp. gall. 0.220) petrol (Esso) ESSO EXTRA for 31 Km. (ml. 19.2624).

Maximum distance of cruising with one tankful, 400 Km. (ml. 249).

250 SCRAMBLER

The consumption at an economical speed of $65 \div 70$ Km/h ($40 \div 44$ m.p.h.) about 1 liter = (imp. gal 0.220 = gall. USA 0.2642) petrol (Esso) ESSO EXTRA for 28 Km. (17,388 miles).

Maximum distance of cruising with one tankful, 308 Km. (ml. 191.268).

HOW TO USE THE SINGLE OVER HEAD CAM-SHAFT MOTORCYCLES

FILLING UP AND STARTING THE ENGINE

Before starting the engine make sure that there is sufficient petrol in the tank, for the distance you wish to travel. See that the petrol tap is on and that the engine lubricating oil is at the right level.

For the lubrication it is advisable to use  **ESSO** EXTRA MOTOR OIL 20W - 30-40 or RACER 40.

Having refueled and checked the oil, see that gear lever is in neutral position and press down the carburetor tickler to ensure the correct level of petrol in the float chamber. Now, after having inserted the contact-key into its place on the headlamp, turn the righthand hand-lebar grip (accelerator) for about one-eighth of its travel

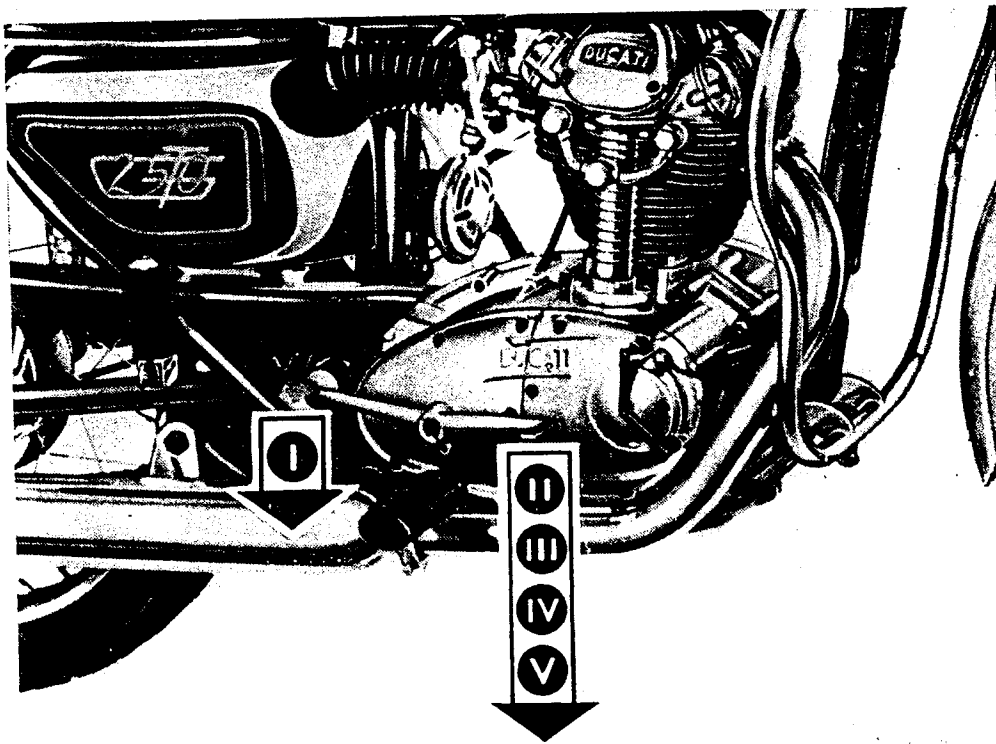

and thrust the kickstarter energetically downward (in the models GT, Monza and Mach/1).

If the engine does not start repeat this operation, varying at the same time more or less the opening of the throttle by means of the handlebar grip. **Once the engine is started, do not race it immediately, especially when the engine is cold, but before accelerating the engine let the lubricating oil warm up to facilitate its circulation throughout the engine, so as to reach all moving parts.**

RIDING AWAY AND RUNNING OF THE MOTORCYCLE

With the engine running, disengage the clutch and using your heel, push down the rear arm of the gearchange lever. When this lever is left to itself it returns to its original position. With this move the bottom gear is now engaged. Now turn the righthand grip little by little and release gradually your hold on the clutch lever; the motorcycle begins slowly to go under way. With the clutch lever completely released let the motorcycle increase its speed until about 15/20 Km/h (9-12 m.p.h.). To pass now from bottom gear in second gear, turn back righthand grip fully and quickly; and after having disengaged the clutch follow up at once by pressing down the front arm of the gearchange lever, with the toe of your shoe. Now turn forward the righthand grip again, releasing at the same time the clutch lever. Similar operations are carried out in order to change from second gear into third gear, from third gear into fourth gear and from the fourth to the top gear.

To change down from a high gear to a lower one, operate as follows: close the throttle, disengage the clutch, accelerate the engine momentarily, thus synchronizing the gear about to be engaged, engage the lower gear and then let go off the clutch control.

A good motorcyclist will make use of the controls intelligently and at the right time. When riding uphill and the engine tends to slow down, change to a lower gear at

once; do not "hang on" to a higher gear when the effort required from the engine advises to use a lower gear.

When the engine turns at a low number of revolutions, do not accelerate its turning at once: thus you avoid any oversupply of fuel and too harsh drive to the transmission.

The clutch should not be held long disengaged with a gear engaged, because the clutch plates will become overheated, causing rapid wear by friction.

Except in case of emergency, never use the brakes brutally when you are already near behind the obstacle, but throttle down the engine in right time and then make use of the brakes.

Bear in mind that insufficiently inflated tyres are detrimental to the roadholding qualities of the motorcycle, cause a greater tyre wear and lower efficiency.

STOPPING THE MOTORCYCLE

To stop the engine, close the throttle completely (the engine will then act as a gentle brake) disengage the clutch and put the gear pedal in neutral. A slight use of the brakes will then stop the motorcycle.

To stop the engine pull out the contact key of the switch placed on the headlamp (in the models GT, Monza, and Mach/1).

MAINTENANCE

On good maintenance depends the good condition of the motorcycle.

By following these fundamental rules you can avoid serious trouble and obtain an excellent performance from your motorcycle.

The operations to be carried out are subdivided in accordance with the order on which depends the mileage run by the motorcycle. The recommendations which follow are, of course, merely indicative, because lubricating, checking and adjustments depend also on the nature of the road, the seasonal temperature, the length of the intervening period.

EVERY 500 Km (about 310 miles)

- Restore the oil-level in the crankcase;
- Check the tyre pressure with a pressure-gauge;
- Tighten the cylinder head holding down bolts;
- Readjust the brakes;
- Check the clearance between valves and rockers, adjusting it to 0.002" to 0.0028" (0.05 to 0.07 mm.) by means of the screws and nuts placed on the rockers, (in the models 250 GT and Monza) and for the appropriate rocker shim on the valve stem end, letting the clearance be 0.15 mm (0.0059 in.) for the suction valve and 0.30 mm (0.0118 in.) for the exhaust valve (in the 250 MACH 1 and MARK III); respectively at 0.15 mm (0.0059 in.) to 0.20 (0.0079") for the SCRAMBLER.

EVERY 1000 Km (about 620 miles)

- Check and adjust the distance between the sparking plug electrodes to about 0.5 mm (0.02") and clean them with a small wire brush and some petrol;

- Clean the contact breaker platinum plates with a rag dampened in petrol and check the distance between the platinum plates, which opening should be 0.3 to 0.4 mm (0.0118" to 0.0157");
- Check the clearance between valves and rockers as mentioned in the above paragraph.

EVERY 1500 Km (about 930 miles)

- Lubricate the speedometer drive with  **ESSO MULTIPURPOSE GREASE H.**

EVERY 2000 Km(about 1240 miles)

- Change the oil in the crankcase draining it while the engine is hot, make sure that the oil drains off completely.
- Remove the carburetor oil filter and wash it in petrol or paraffin oil, in order to remove all impurities from the gauze.
- Clean out the carburetor float chamber, the main jet and the idle jet.
- Readjust the clutch because the wear on its linings might otherwise cause slip.
- Lubricate the hinge of the rear fork.
- Dampen with 2 drops (not more) of thin mineral oil the lubricating wick of the contact breaker cam.
- Tighten uniformly the nipples of the spokes and check whether the screws and the nuts of the wheels have been firmly tightened.

EVERY 20.000 Km(about 12400 miles)

- Dismantle the exhaust pipe and the cylinder, in order to remove the carbon deposits on the cylinder head and on the piston (this should be done by a Ducati Servicing Garage).

HEADLAMP ALIGNMENT

It is advisable to check periodically the alignment of the headlight as follows:

- place the motorcycle at a distance of 5 meters (ft. 16.404) from a bright wall;
- make sure that the ground be even and that the optic axis of the headlamp be perpendicular to the wall;
- the motorcycle with its rider must rest on the wheels, not on the central stand;

250 GT - MONZA - MACH/1 - MARK III

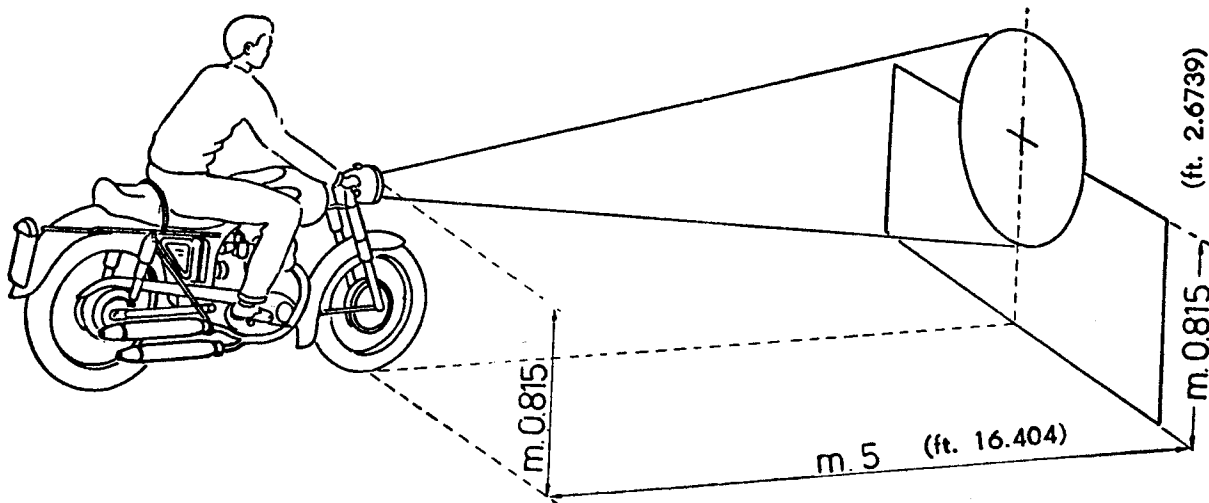

250 SCRAMBLER

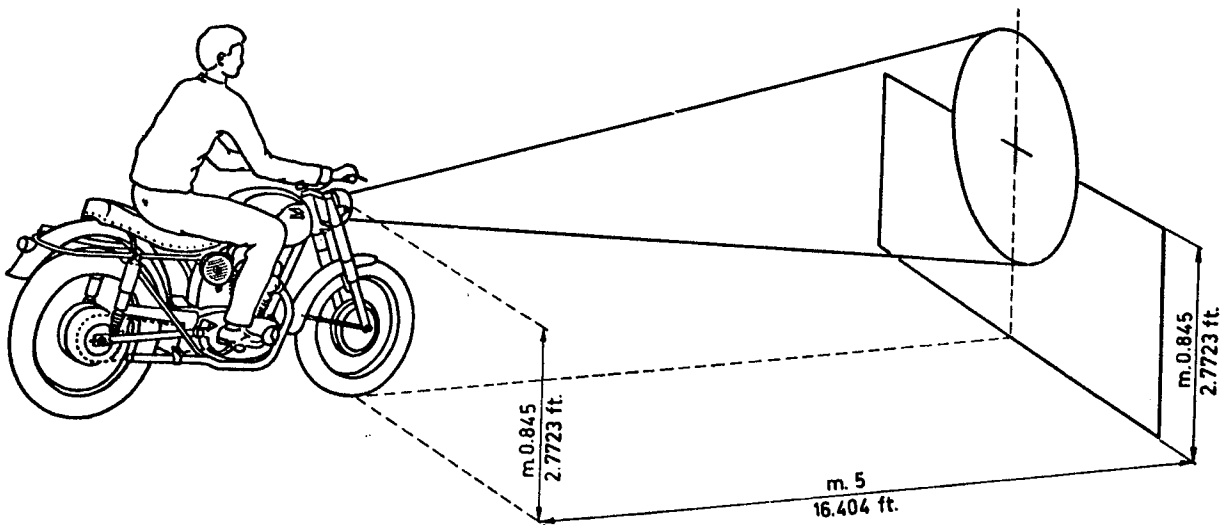

- trace a cross in the intersections between the optic axis and the wall, that is at a height of 0.815 meter (ft. 2.6739) from the ground for 250 GT, Monza, Mach/1, Mark III and 0.845 meter (ft. 2.7723) for the 250 Scrambler.
- when the depthlight is lighted up, the cross must be in the center of the circular light-beam hitting the wall.
- to rectify eventually the alignment of the headlamp, operate by means of the two fixing screws of the tab nuts of the headlamp on the front fork.

OVERALL CLEANING

The motorcycle should be washed and cleaned periodically, according to the length of time it has been used and the state of the road.

- Clean the engine with parafin and wipe it dry with a clean rag;
- wash down the painted parts of the frame with water, using a sponge for washing and a shammy leather for drying;
- never use solvents, petrol, spirit or parafin, otherwise the paint will look flat;
- grease the chromium plated parts with vaseline and polish with shammy leather.

PROLONGED REST OF THE MOTORCYCLE

If the motorcycle has to be put at rest for several months, it is advisable to proceed as follows:

- clean the motorcycle thoroughly;
- empty the petrol tank;
- take out the battery and keep it efficient, as per instructions hereunder in the models GT, Monza Mach/1;
- squirt through the hole of the sparking plug, several drops of oil into the cylinder and turn the engine by hand for several revolutions, distributing a thin oil-film on the walls;
- put the motorcycle upon two pieces of wood, lifting the machine from the ground and empty the air out of the inner tube;
- cover the machine with a canvas, or water-proof cover.

INSTRUCTIONS FOR THE FIRST CHARGE AND FOR THE MAINTENANCE OF THE BATTERY (250 G.T. - MONZA - MACH/1)

Battery SAFA 3L3, with free acid, dry charge.

Type

- tension 6 V
- Capacity at 20 hours 13.5 Ah
- Capacity at 10 hours 12 Ah
- Normal charging current 1.2 Amp
- Max, recharging current 2 Amp
- External dimensions 120 x 90 x 165 mm. =
4.7244x3.5433x6.3960"

Warning

The battery, must always be preserved in a fresh but dry place. It is important to check frequently the level and the density of the electrolyte.

Never let the accumulators completely without charge. Keep always the plugs well closed and screwed down. Clean always well the oxyde from the terminals and connections, and protect them with a thin layer of pure vaseline. Never use grease. The battery must always be preserved well cleaned and dry, especially the top part.

Electrolyte

The electrolyte consists of sulphuric acid of regular purity, diluted with distilled water, so that the density, referred to a temperature of 15° C (59° F.), corresponds to the following values:

CONDITIONS PLACE	DENSITY OF THE ELECTROLYTE		Max. temperat. of the electrolyte during charge
	dry battery	charged battery	
Temperate climate	1,28 ÷ 1,29	1,27 ÷ 1,28	50°C (122°F)
Tropical climate	1,21 ÷ 1,22	1,20 ÷ 1,21	60°C (140°F)

The level of the electrolyte within the elements must be at the same level of the antispash gauze. When all elements have been filled with the electrolyte,

let the battery at rest for about 2 hours to allow the cooling of the plates.

A certain part of the electrolyte will be absorbed by the separators and by the plates, so that it will be necessary to add more electrolyte to establish the right level.

To check the electrolyte level use only glass sticks or ebonite.

First charge

Take down the breathers and connect the battery with a source of direct current, having an intensity equal to 1/10 of the normal 10 hours capacity, for a maximum period of at least 10 consecutive hours.

Take care that during the charge the temperature of the electrolyte does not overpass 50° C (122° F).

The charge has to be interrupted:

- a) when the above mentioned effective number of hours is elapsed, reckoning of course also the eventual interruptions;
- b) in case of an intense ebullition in all the elements;
- c) in case if for at least 3 consecutive readings at intervals of one hours each, the density of the electrolyte, and the voltage of each element remain the same.

At the end of the charge, the electrolyte should have recovered the initial density, and the voltage of each element should arrive at a minimum of 2.7 Volts under charge, that is 8.1 Volts for a battery of 3 elements and of 16.2 Volts for a battery of 6 elements.

At this point the battery is ready to be put in service.

SUCCESSIVE CHARGES

The successive charges have to be made preferably with a current having an intensity in Amp. equal but not greater than 1/10 of the normal 10 hours capacity.

If during the charge the temperature, checked with a suitable thermometer immersed into the electrolyte should reach 50° C, (122° F), it will be necessary to reduce or to interrupt the charge until the temperature falls at least below 40° C (104° F).

The charge must continue until the density of the electrolyte results to be constant during 3 consecutive readings made at intervals of one hour each, and until the voltage reaches the value of 2.7 Volts for each element. **Never and for no reason refill the battery with sulphuric acid of whatever density.** The refilling has to be made only with distilled water, chemically pure, taking care that the vessel used on this behalf be absolutely clean, to avoid the spoiling of the electrolyte by noxious substances and compromise so the efficiency of the battery. In case the accumulators remain temporarily inactive, it is necessary to recharge the battery at least once each month, and each time the battery will be put in service.

INSTRUCTIONS FOR THE MAINTENANCE OF THE ELECTRICAL SYSTEM

(GT - MONZA - MACH/1)

In case of inspections or repairs, it is extremely important to know the working of the electrical system and to follow with care the scheme on page 38.

To avoid demagnetizing of the rectifier, be careful never to send electrical current (direct or alternate current) in the opposite direction.

Every inspection should be made with a convenient Ohmmeter.

To avoid ruining the efficiency of the rectifier, never run the engine without battery.

For no reason, the rectifier and static regulator of current should be opened: if it does not work, send it to the CONCESSIONAIRES of DUCATI MECCANICA for replacement.

SERVICE STATION

TOOLS FOR SERVICE STATION

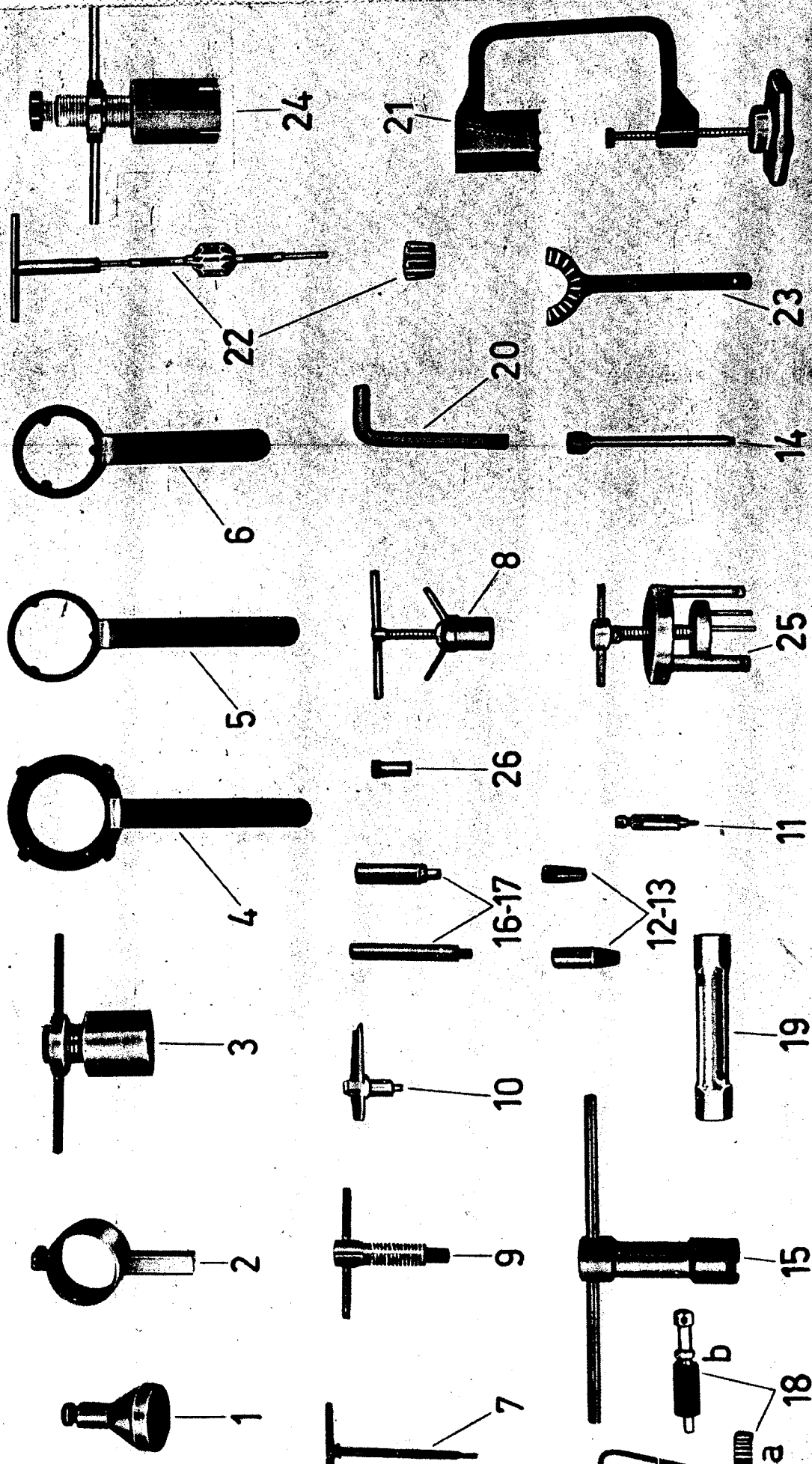

TOOL EQUIPMENT LEGEND

- 1) Flywheel puller
- 2) Piston cleaning tool
- 3) Puller for journal bearing bushing
- 4) Housing-holding key for tightening the engine shaft gear
- 5) Drum-holding key for tightening the drum nut
- 6) Gear-holding key for tightening the pinion nut
- 7) Spanner for nuts with hollow hexagon (ch. 5 (0.1968"') or ch. 6 - (0.2362"')
- 8) Valve seats grinding tool
- 9) Puller for clutch side cover
- 10) Piston position indicator
- 11) Rocker pin puller
- 14) Line-up pin for rocker bushing or washer assembly
- 15) Timing camshaft holding key for tightening of the bevel gear Z = 28
- 16-17) Pin for assembling and dismantling of gudgeon pin
- 18) Engine shaft holding tool for tightening of the bevel gear Z = 21
a) with assembled cylinder head b) with dismantled cylinder head
- 19) Spanner for bevel gear Z=28 (see 15)
- 20) Plug assembly spanner for plugs with hollow hexagon (ch. 12 (0.4724"') or ch. 14 (0.5512"')
- 21) Valve assembling and dismantling tool
- 22) Grinder for valve seats (one for the inlet and one for the exhaust)
- 23) Key for threaded ring of exhaust pipe
- 24) Ball bearing puller (3 types)
- 25) Plate for removing half-crankcase (on request)
- 26) Bush for the assembly of the advance ignition cover

SERVICE STATION

TOOL EQUIPMENT
DIRECTIONS FOR USE

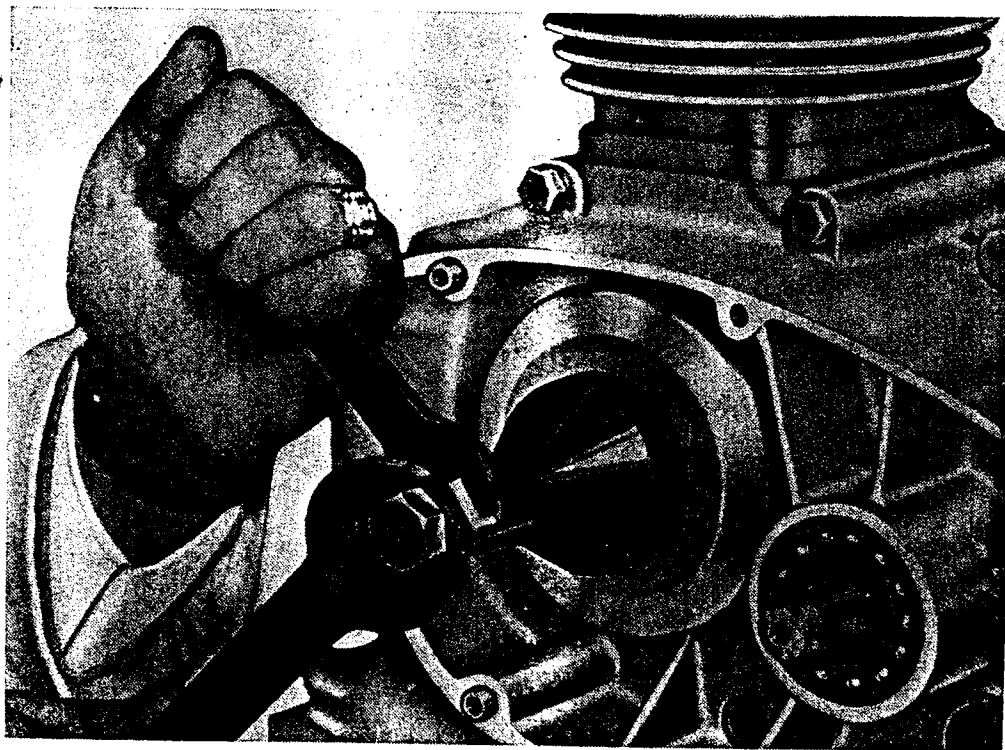

1 - Flywheel puller

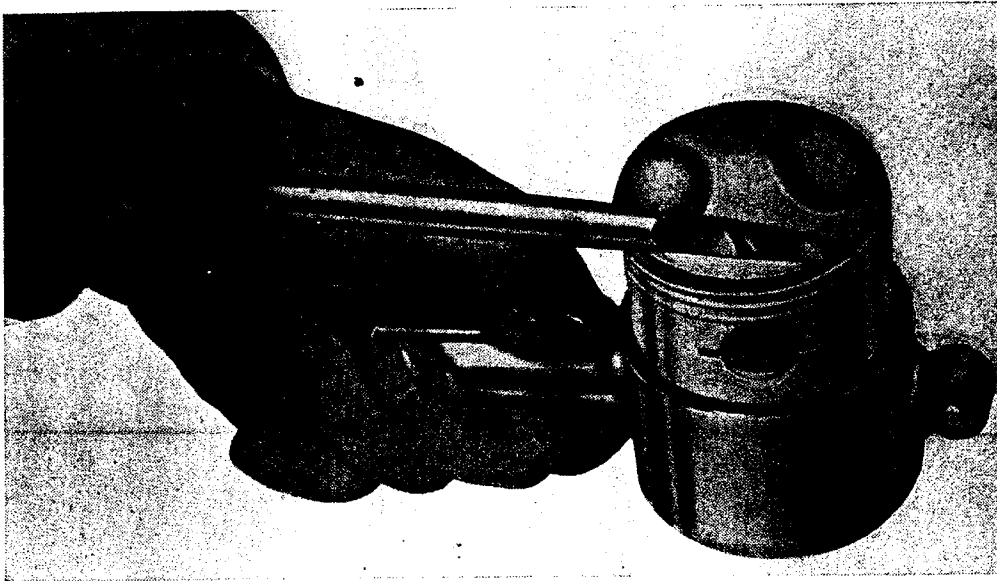

2 - Piston cleaning tool

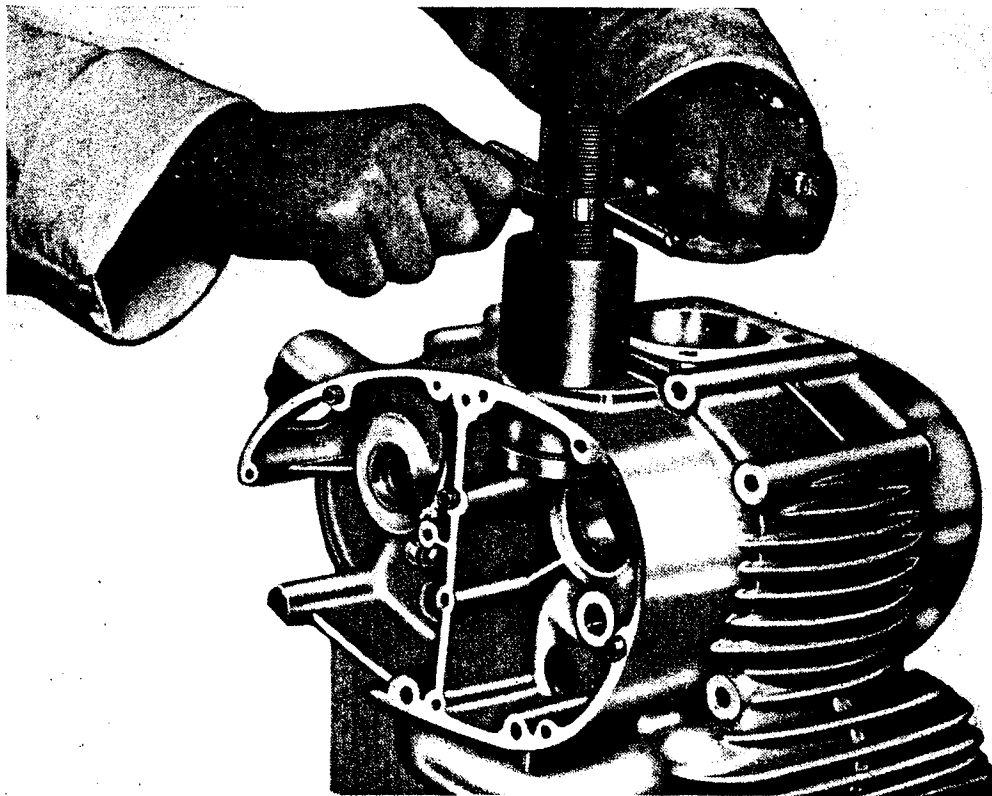

3 Puller for journal bearing bushing

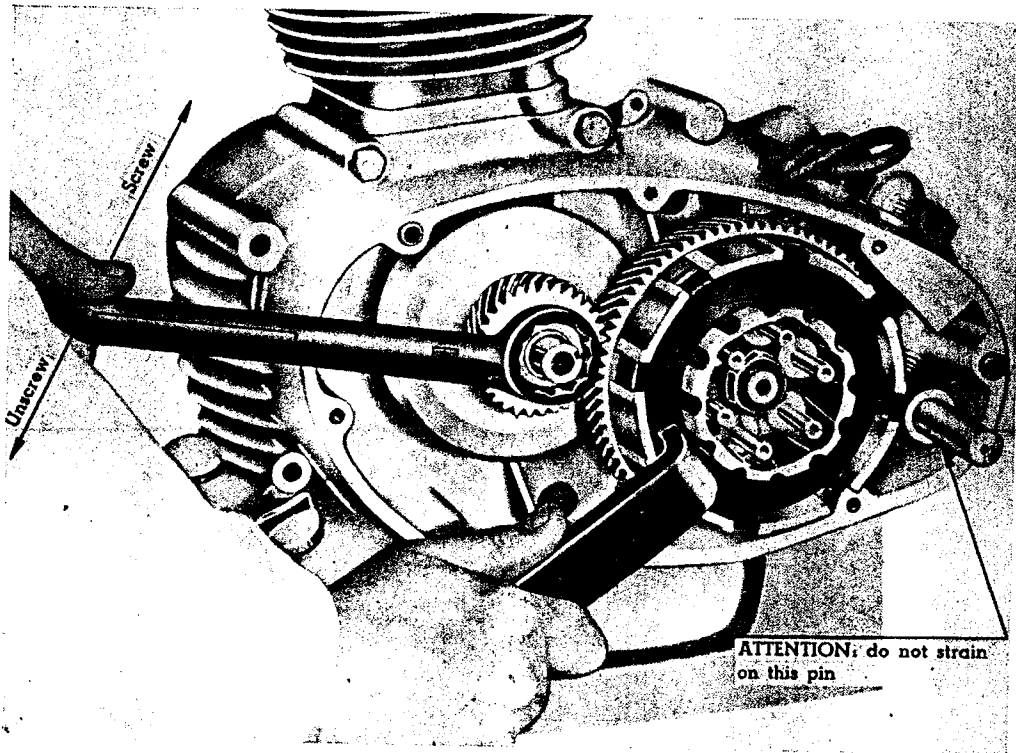

4 - Housing-holding key for tightening the engine shaft gear

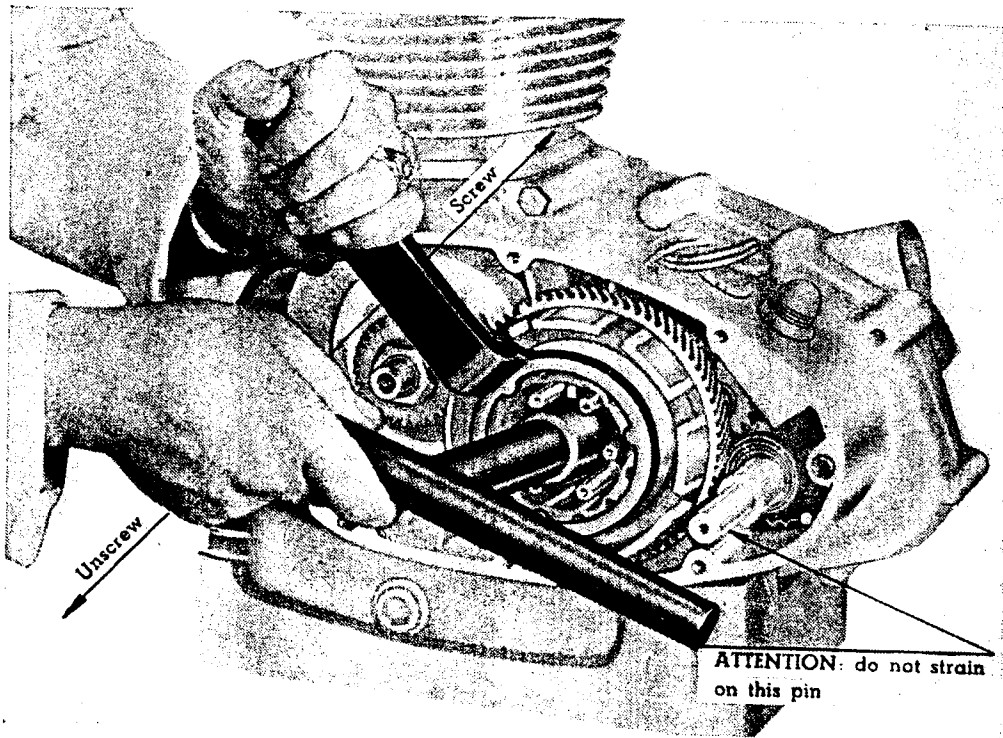

5 - Drum-holding key for tightening the drum nut

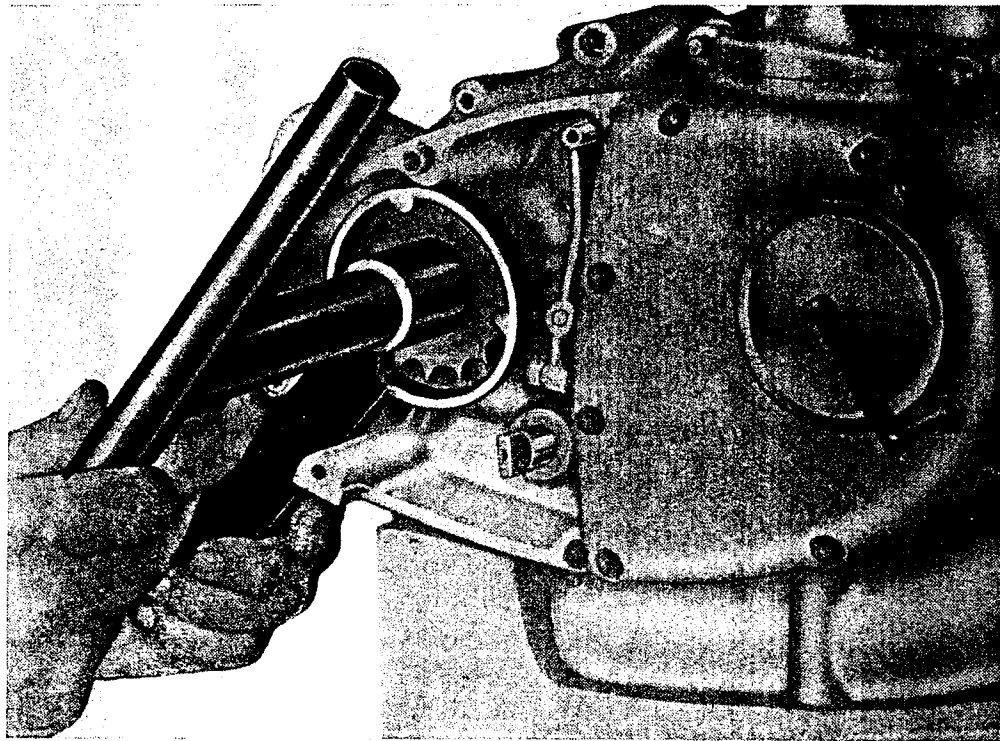

6 - Gear-holding key for tightening the pinion nut

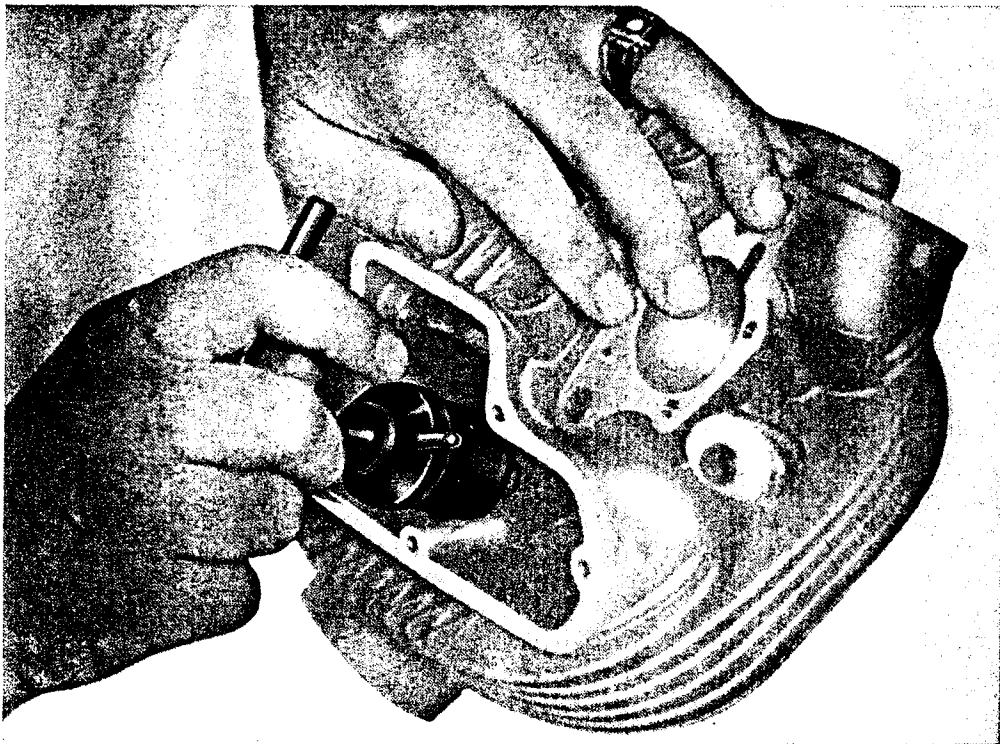

8 - Valve seats grinding tool

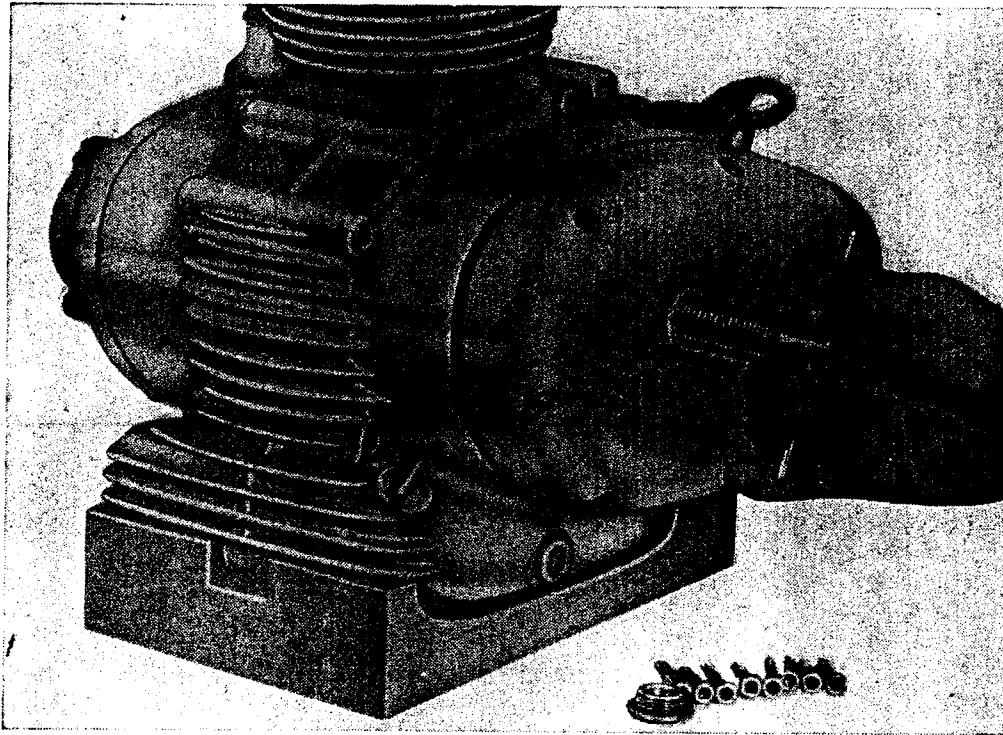

9 - Puller for clutch side cover

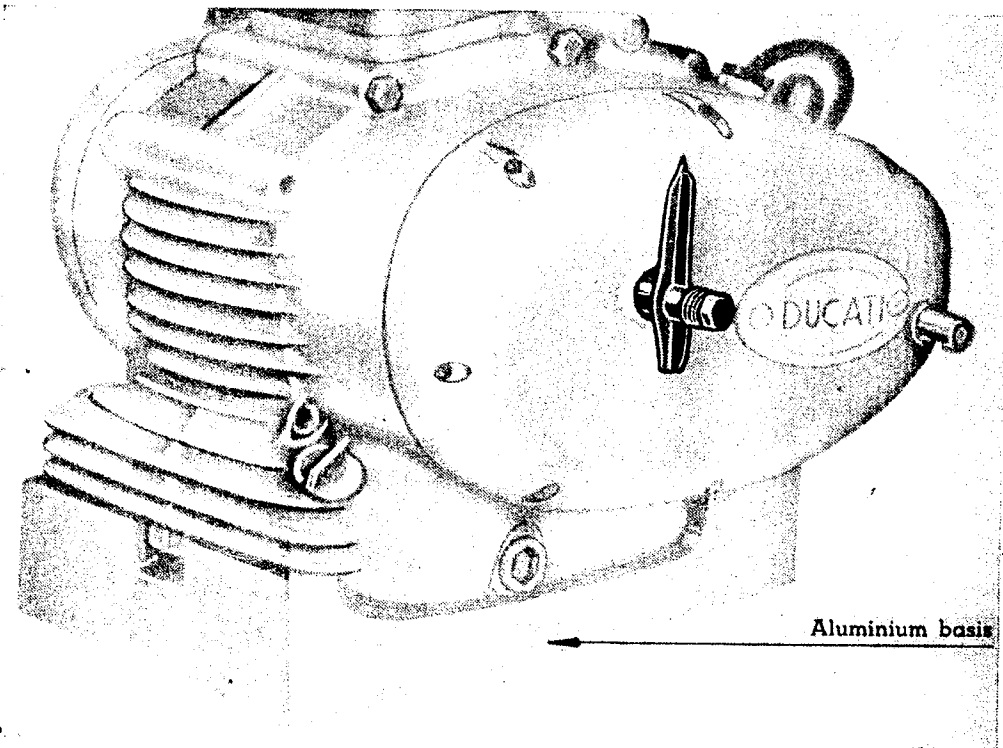

10 - Piston position indicator

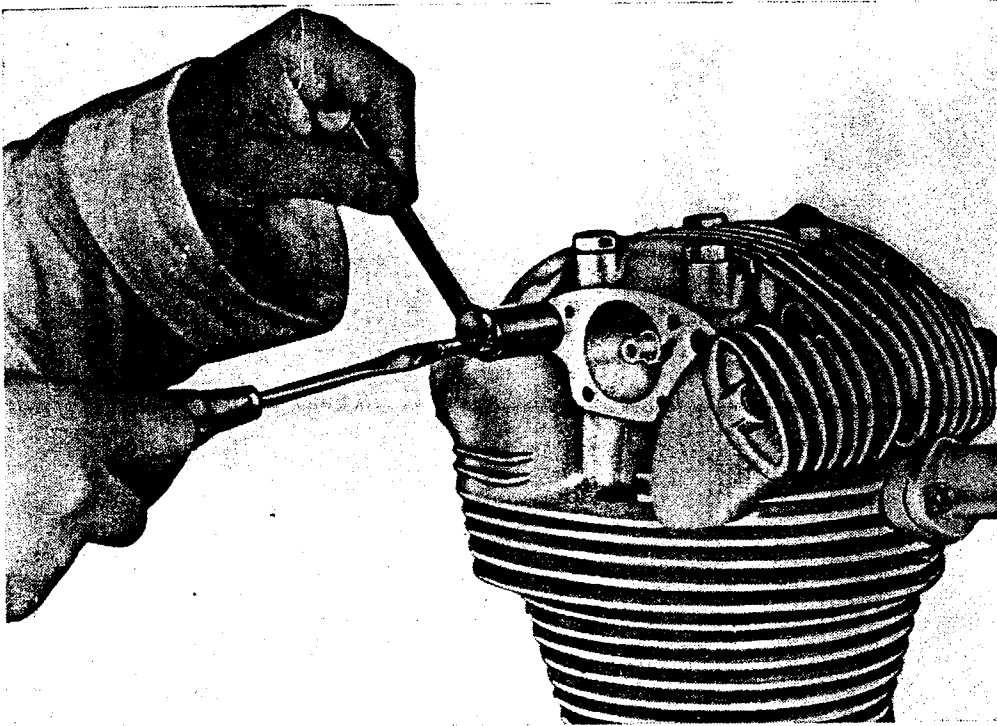

11 - Rocker pin puller

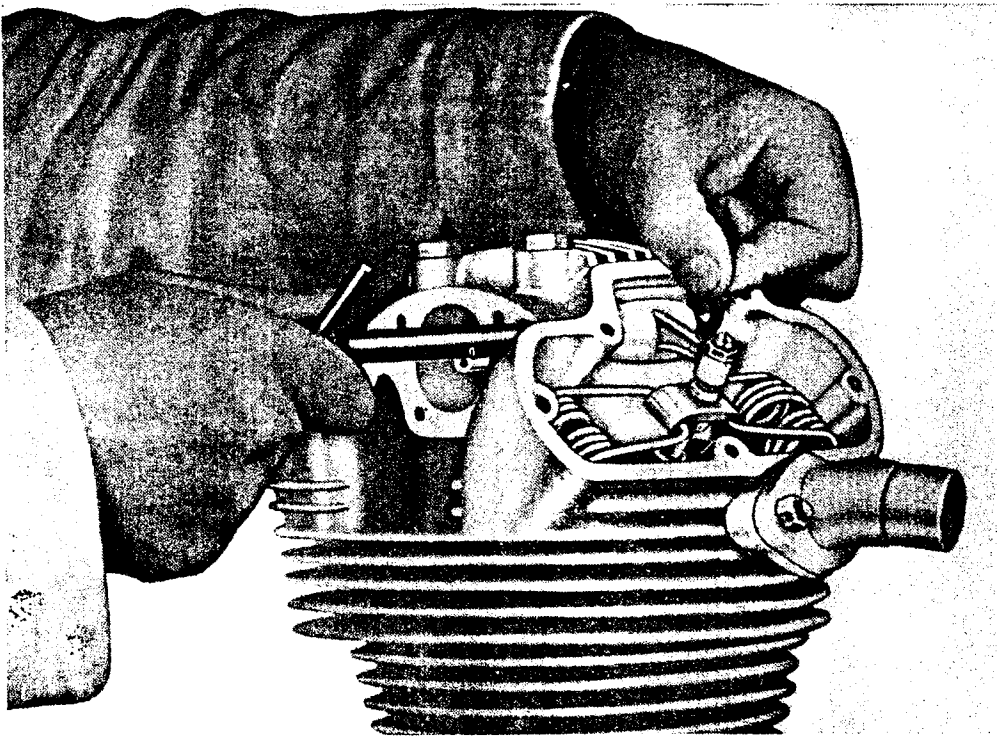

14 - Line-up pin for rocker bushing or washer assembly

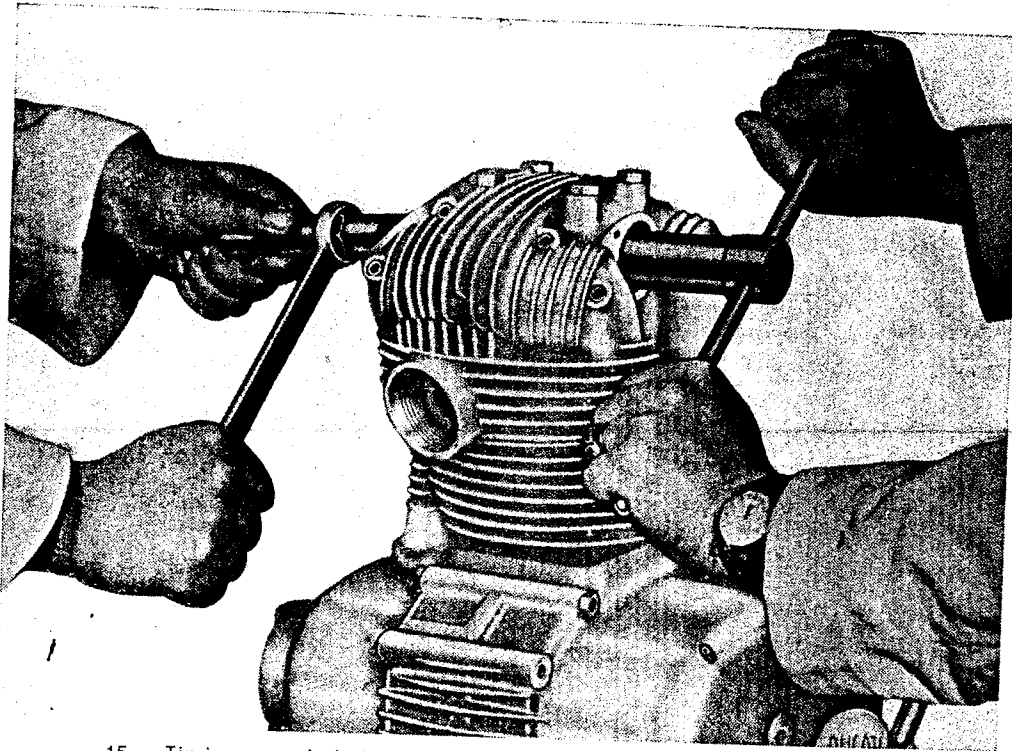

15 - Timing camshaft holding key for tightening of the bevel gear

The little slot must be on
the front side of the engine

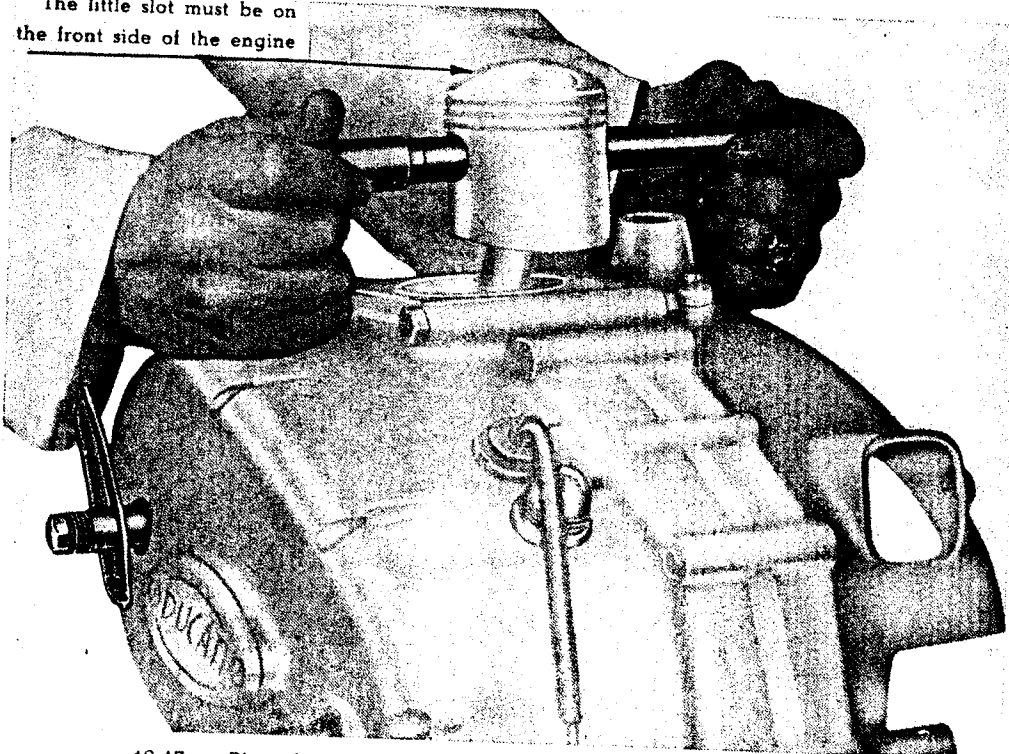

16-17 - Pins for assembling and dismantling of gudgeon pin

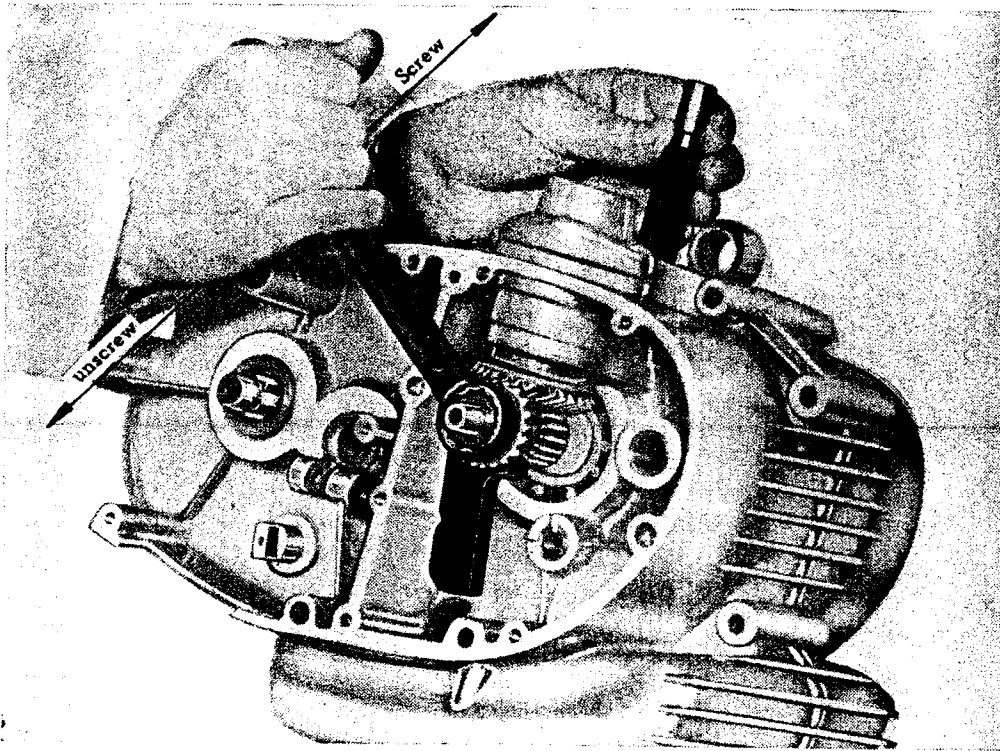

18 - Engine shaft holding tool for tightening of the bevel gear Z=21

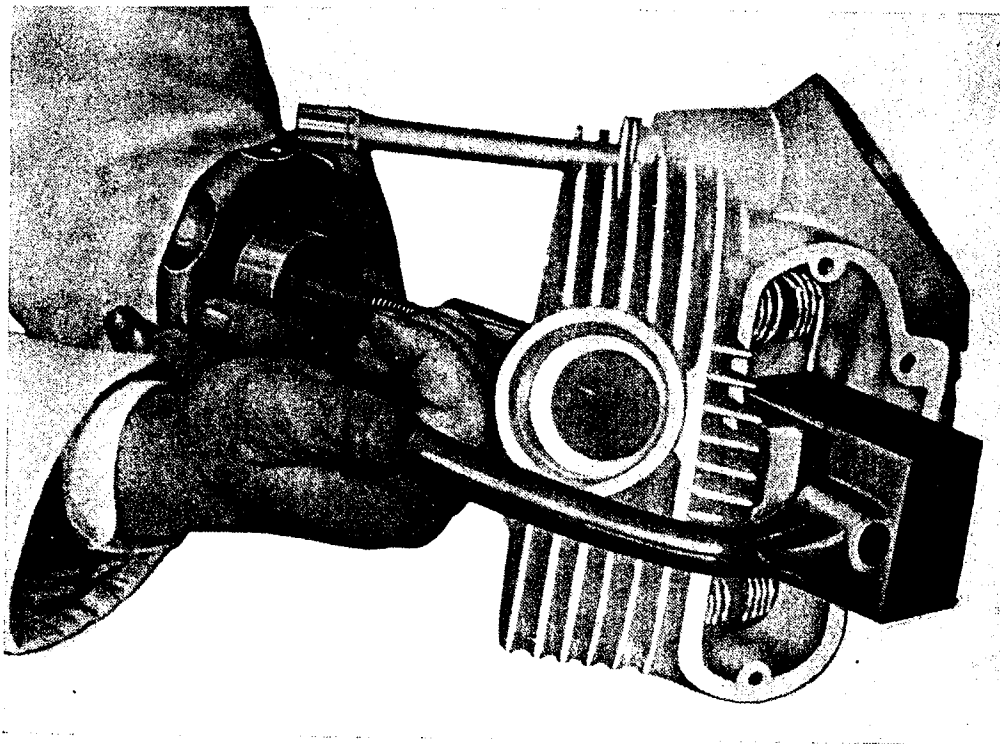

21 - Valve assembling and dismantling tool

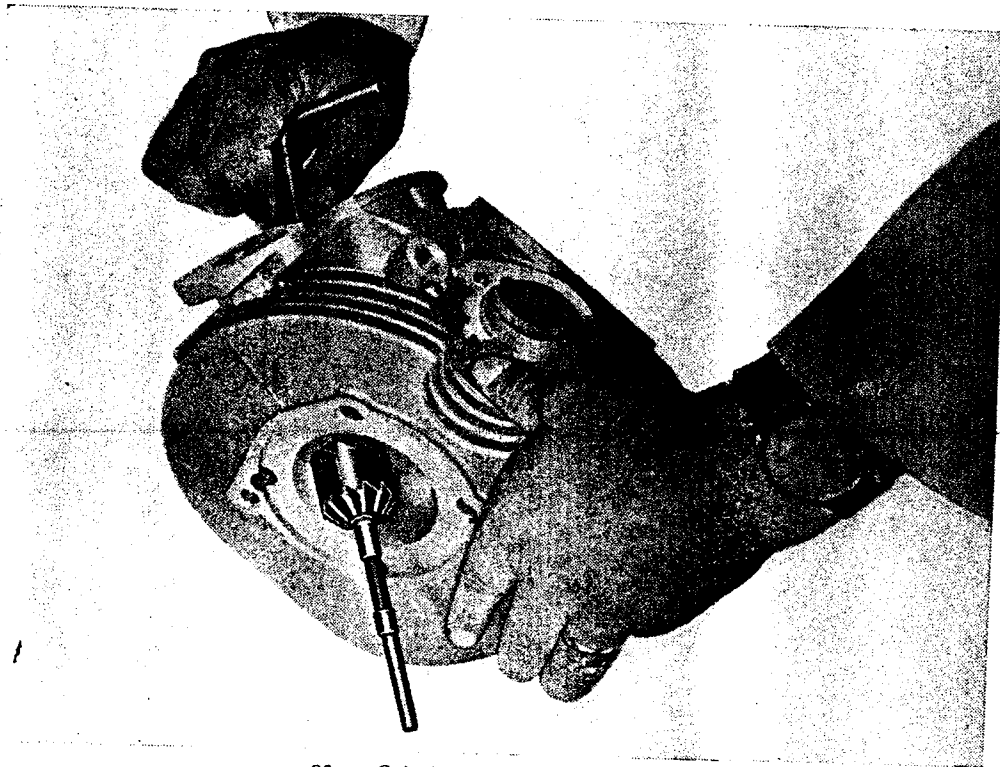

22 - Grinder for valve seats

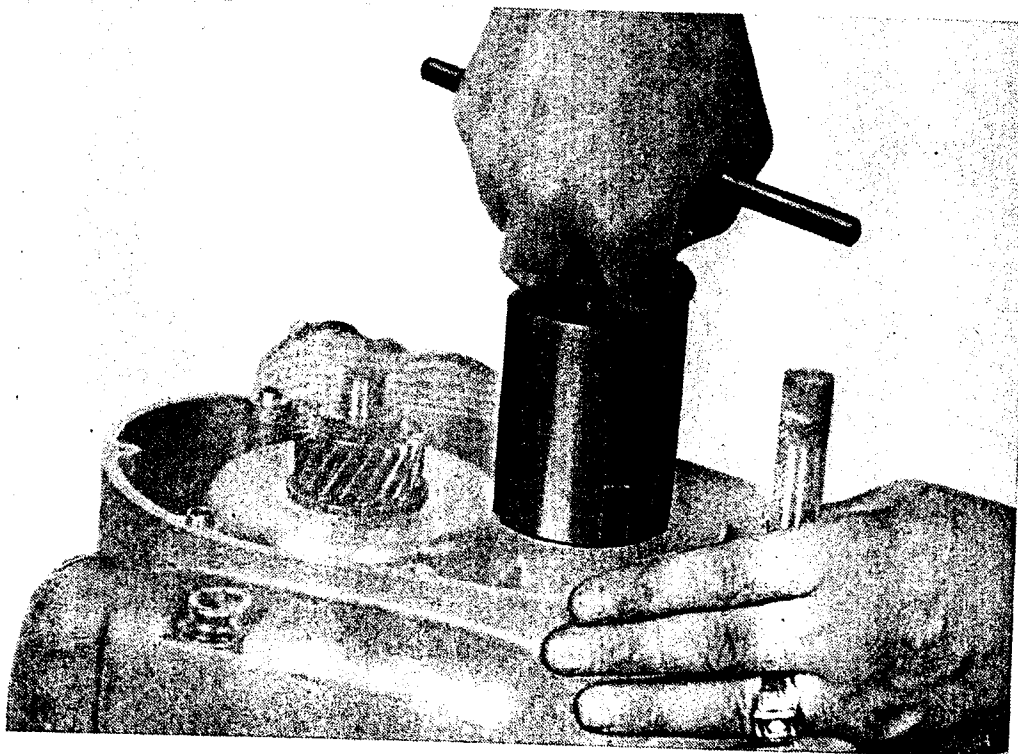

24 - Ball bearing puller

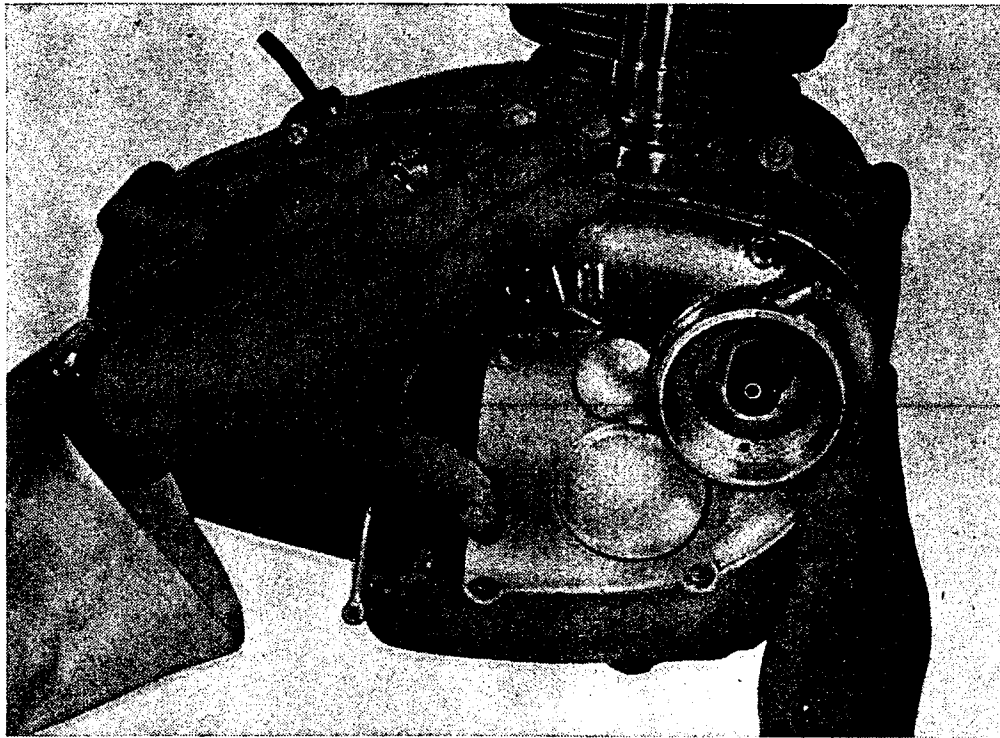

26 - Bush for the assembly of the advance ignition cover



LOCATING AND REMEDYING FAULTS

The following list contains several of the most frequent faults which may arise and advice on remedying them.

ENGINE DOES NOT START EASILY

First of all, ascertain that there is enough petrol and that the cock is turned on. (A = open; R = reserve). If these are in order, the fault may be one or more of the following:

C A U S E	R E M E D Y
Petrol pipe is clogged.	Blow through it until the obstacle is removed.
Petrol filter dirty.	Dismantle the filter and clean the gauze by air blast.
Petrol cock filter is dirty.	Dismantle the filter and clean it by a blast of air through the gauze.
Carburetor float stuck.	Remove the float and clean out the float chamber (this should be done by a DUCATI Servicing Garage).
Carburetor float leaking.	Change the float (at a DUCATI Servicing Garage).
Jet is clogged.	Remove the obstacle by a strong blast of air.
The cable of the ignition coil is broken or sparking externally.	Inspect the cable insulation for faults and if necessary change the cable at a DUCATI Servicing Garage.
Defective sparking plug.	Change or clean the plug, making sure that the insulation core is not damaged, that there are no carbon deposits on the electrodes and that the spark gap does not exceed 0.5 mm. (0.0197").

C A U S E	R E M E D Y
<p>The contact breaker points do not open.</p>	<p>Check the position of the fixed contact point (at a Ducati Servicing Garage).</p>
<p>The contact breaker arm seized on its pivot.</p>	<p>Check movement between rocker arm and pivot and if necessary lubricate the pivot.</p>
<p>The contact breaker points are dirty.</p>	<p>Clean the contact breaker points with a rag damped in petrol.</p>
<p>The capacitor has broken down or is short circuited.</p>	<p>Change the capacitor (at a Ducati Servicing Garage).</p>
<p>Compression lacking.</p>	<p>Check if the sparking plug has been tightly screwed in, check the valves for gas-tightness and the tightness of the piston rings (at a Ducati Servicing Garage).</p>
<p>A valve spring is broken.</p>	<p>Change the broken spring (at a Ducati Servicing Garage).</p>
<p>Valve sticking.</p>	<p>Dismantle the valve, clean the valve stem and the bore of the valve guide, and make sure that the clearance between stem and bore does not exceed 0.08 mm. (0.0032") (at a Ducati Servicing Garage).</p>
<p>The adjustment screw for the tappet clearance is loose (250 GT-Monza).</p>	<p>Readjust the clearance and tighten the set-nut properly.</p>
<p>The rocker adjuster is worn out (250 MACH 1 - MARK III - SCRAMBLER).</p>	<p>Check again the clearance by fitting the adequate rocker shim on the valve stem end.</p>
<p>The battery is discharged (250 GT - MONZA - MACH/1).</p>	<p>Recharge the battery according with the instructions of page 52 (at a Ducati Servicing Station).</p>

C A U S E	R E M E D Y
<p>The battery quickly discharges for a fault or an interruption in the recharging circuit. (250 GT - MONZA MACH 1).</p>	<p>Disjoin the wire from the +terminal block of the battery.</p> <ul style="list-style-type: none"> — Insert an amperemeter in continuous current between the terminal block and the wire. — Insert the ignition key and let the engine turn. <p>The headlamp warning red light should be cut out when the engine runs at 1,000 r.p.m.</p> <p>Checking the Electrical System.</p> <p>Make sure that all the bulbs are efficient.</p> <ol style="list-style-type: none"> 1) With the lights switched out (during the day), the amperemeter should read 0 at 1,200 r.p.m. approx. 2) With town lights switched on (during the night) the amperemeter should read 0 at 1,400 r.p.m. approx. 3) With the antidazzle lights switched on (during the night) the amperemeter should read 0 at 2,200 r.p.m. approx.

INEFFICIENT ENGINE

C A U S E	R E M E D Y
<p>Irregular feed of petrol to the carburetor.</p> <p>Main jet partly clogged.</p> <p>Carburetor butterfly valve does not open completely.</p> <p>The float needle does not close properly.</p> <p>Petrol of bad quality.</p> <p>The spark is not of the right type.</p> <p>The sparking plug cable sparks externally.</p>	<p>Clean the carburetor filter, the petrol cock filter and the petrol pipe.</p> <p>Clean the main jet by means of an air blast.</p> <p>Readjust the valve travel by means of the adjustment screw of the carburetor Bowden cable (at a Ducati Service Garage).</p> <p>Clean out the carburetor and especially the needle seat (at a Ducati Servicing Garage).</p> <p>Empty the petrol tank and refill at a reliable garage.</p> <p>If the sparking plug overheats, you will have preignition, knocking, and misses, especially at high revs. If the sparking plug remains too cold, you will have no ignition, because the electrodes will short-circuit. Use the right type of sparking plug; we advise the use of a plug having a thermal figure of 260 of the Bosch international scale.</p> <p>Tighten the plug down well. A copper washer should always be placed between the sparking plug and its seating in the cylinder head.</p> <p>Change the cable or repair the insulation (at a Ducati Servicing Garage).</p>

C A U S E	R E M E D Y
<p>The spark gap between the electrodes of the sparking plug is too wide.</p>	<p>Adjust the gap to the proper width of about 0,5 mm. (0.0197").</p>
<p>The sparking plug electrodes are dirty.</p>	<p>Clean the electrodes with a wire brush.</p>
<p>The contact breaker opening is excessive.</p>	<p>Readjust the exact opening of the contact which is 0.3÷0.4 mm. = 0.0118" to 0.0157" (at a Ducati Servicing Garage).</p>
<p>The secondary winding of the coil is short-circuited or broken.</p>	<p>Change the coil (at a Ducati Servicing Garage).</p>
<p>The silencer is almost completely clogged-up.</p>	<p>Clean the silencer, to ensure the free discharge of the spent gases.</p>

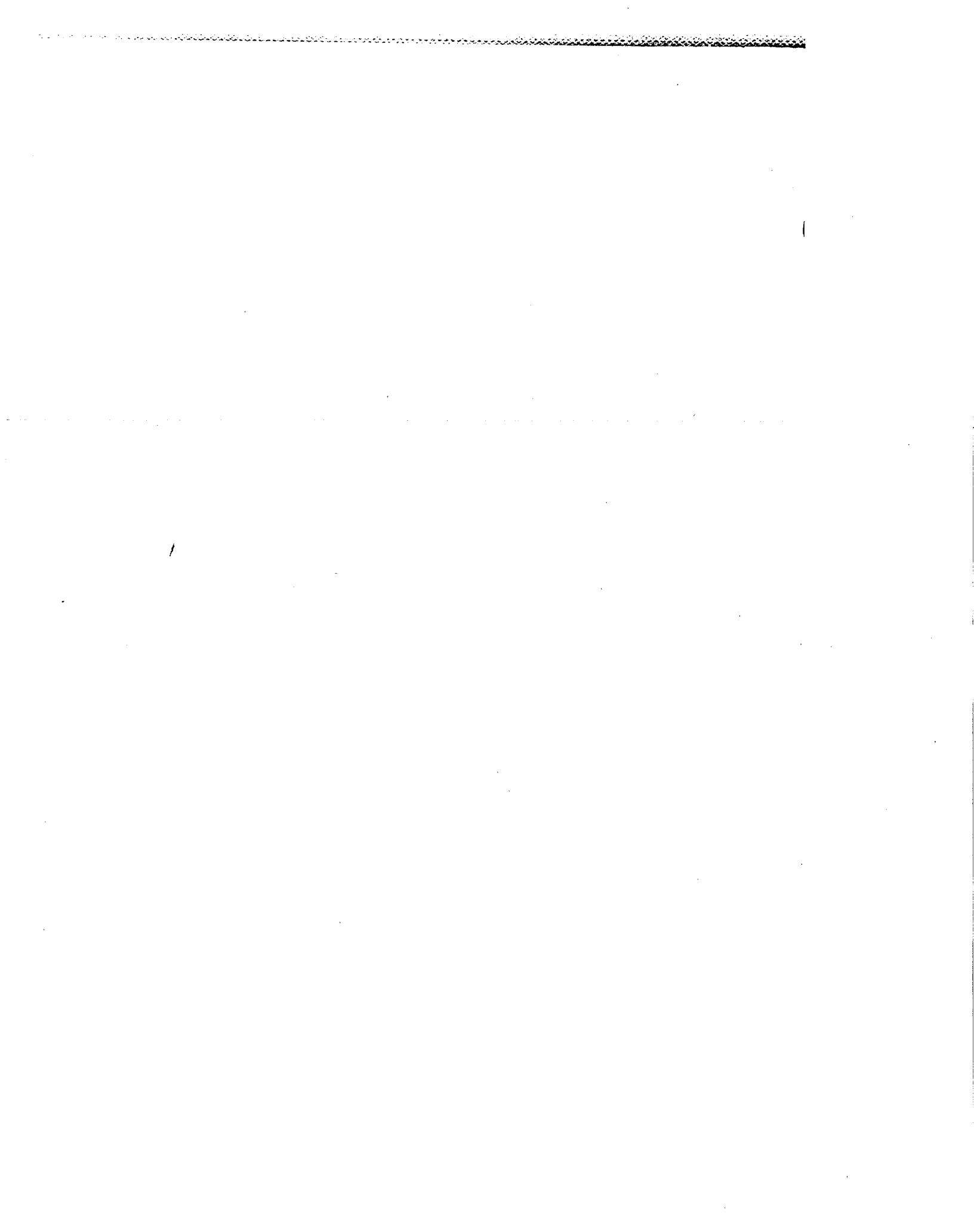

I N D E X

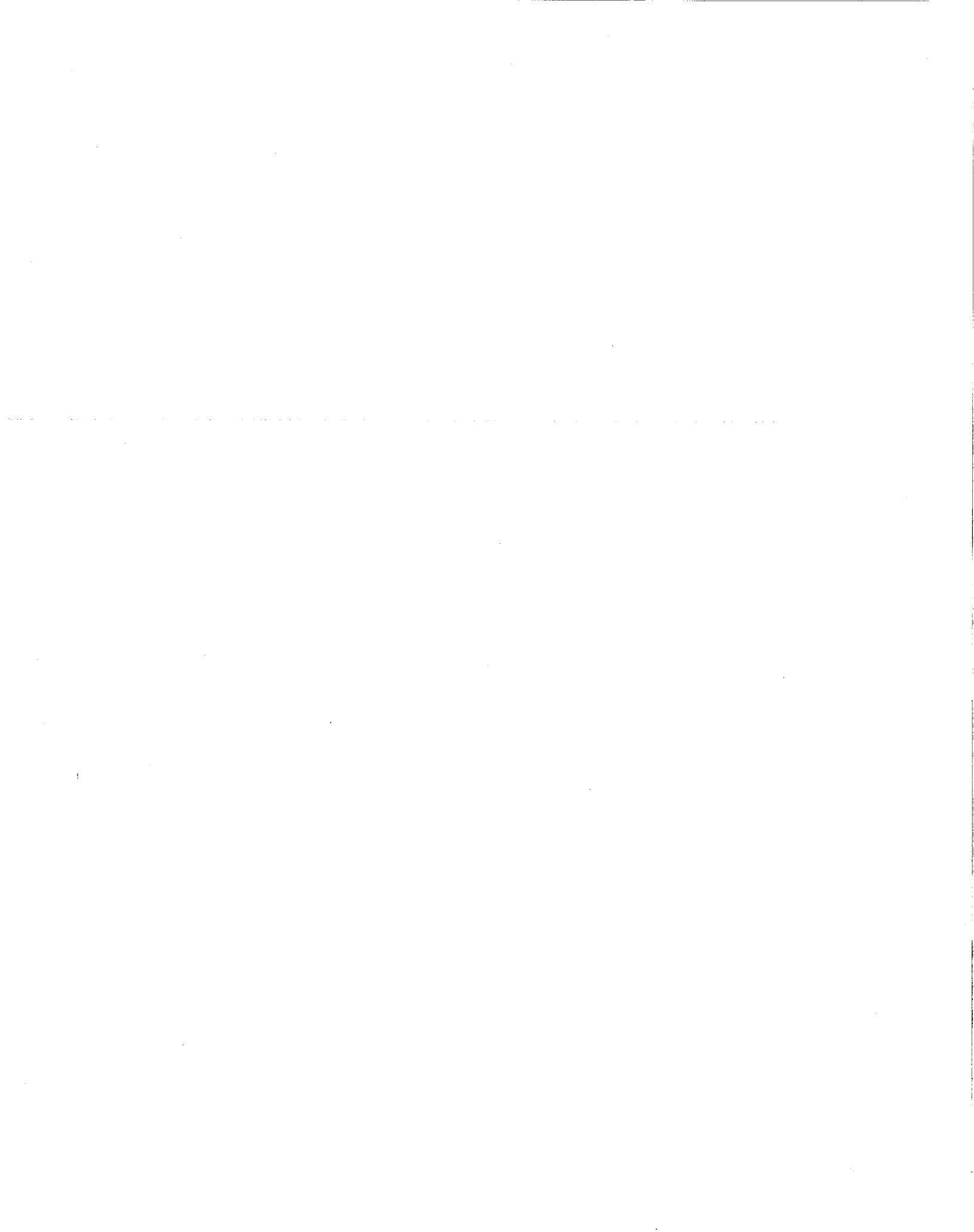

INDEX

	Pag.
GUARANTEE CARD	2
FOREWORD	» 10
Spare Parts	» 11
Ducati Servicing Garage	» 11
IDENTIFICATION NUMBERS	» 12
PRECAUTIONS TO BE FOLLOWED DURING THE INITIAL RUNNING - IN PERIOD	» 13
MAIN SPECIFICATIONS	
Engine	» 15
Timing	» 16
Petrol Feed	» 24
Lubrication	» 24
Centrifugal oil filter	» 27
Cooling	» 27
Ignition	» 28
How to check advance	» 29
Starting	» 33
Transmission	» 33
Frame	» 34
Suspension	» 34
Wheels	» 35
Brakes	» 36
New Electrical System	» 36
Advantages of the new electrical equipment	» 37
Electrical system (250 MARK III - Scrambler)	» 39
Controls	» 41
Saddle	» 41
Adjusting of the Chain Tension	» 42
Overall dimensions and Weight	» 43
Tool box	» 44
Performance	» 45
HOW TO USE THE O.H.C.-SHAFT MOTORCYCLES:	
Filling up and starting of the engine	» 49
Riding away and running of the Motorcycle	» 50
Stopping the Motorcycle	» 51
MAINTENANCE:	
Every 500 Km. (310 miles)	» 52
Every 1000 Km. (620 miles)	» 52
Every 1500 Km. (930 miles)	» 53
Every 2000 Km. (1240 miles)	» 53
Every 20000 Km. (12400 miles)	» 53
Headlamp alignment	» 54
Overall cleaning	» 55
Prolonged rest of the Motorcycle	» 55
Instructions for the first charge and for the maintenance of the Battery	» 56
Instructions for the maintenance of the electrical system	» 58
DUCATI SERVICE STATIONS	» 59
LOCATING AND REMEDYING FAULTS:	
Engine does not start easily	» 73
Inefficient Engine	» 76



DUCATI MECCANICA S.p.A - BOLOGNA
(BORGO PANIGALE) CASELLA POSTALE 313
TELEFONO N. 491601 (quattro linee) TELEGRAMMI "DUCATIMEC,, - BOLOGNA